



TX6206

300mA Low Power LDO

<http://www.txsemi.com>

Features

- Low power consumption
- Low voltage drop
- Low temperature coefficient
- Low Quiescent Current: 3uA at 6V
- Output voltage accuracy: tolerance $\pm 2\%$

Applications

- Battery-powered equipment
- Reference voltage sources
- Cameras, video cameras
- Portable AV systems
- Mobile phones
- Portable games

General Description

TX6206 series are a highly precise, lower consumption, 3 terminal, positive voltage regulators manufactured using CMOS and laser trimming technologies. The series provides large currents with a significantly small dropout voltage.

The TX6206 consists of a current limiter circuit, a driver transistor, a precision reference voltage and an error correction circuit. The series is

compatible with low ESR ceramic capacitors. The current limiter's foldback circuit operates as a short circuit protection as well as the output current limiter for the output pin. Output voltages are internally by laser trimming technologies. It is selectable in 0.1V increments within a range of 1.2V to 5.0V. TX6206 series are available in SOT-23, SOT23-3 and SOT-89 packages.

Typical Application

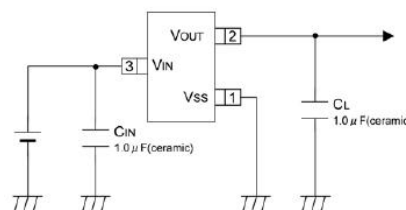

Order Information

TX6206-①②③④

Designator	Symbol	Description
①②	Integer	Output Voltage(1.2~5.0V)
③	N	Package:SOT23
	M	Package:SOT23-3
	P	Package:SOT89A
	P1	Package:SOT89B
④	R	RoHS / Pb Free
	G	Halogen Free

Note: "①②" stands for output voltages. Other voltages can be specially customized



TX6206

<http://www.txsemi.com>

300mA Low Power LDO

Block Diagram

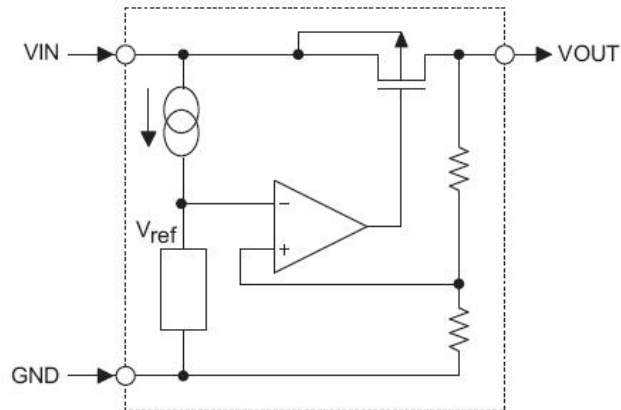

Pin Assignment

SOT23-3 and SOT23 (Top view)

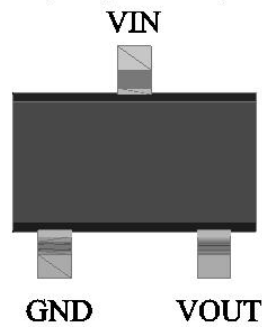

SOT89 A (Top view)

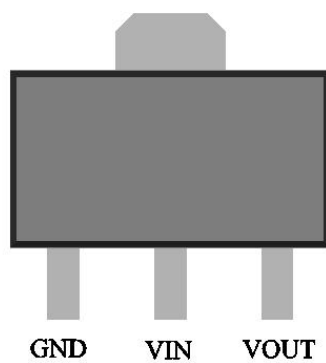

SOT89 B (Top view)

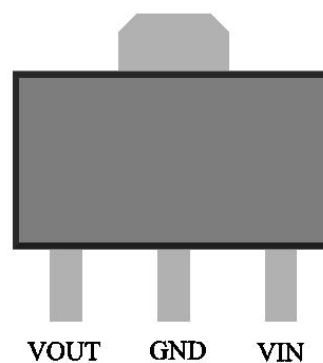



TX6206

<http://www.txsemi.com>

300mA Low Power LDO

Marking Rule

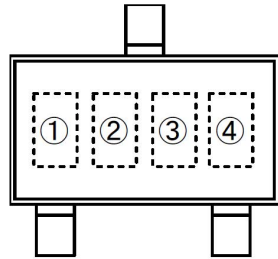

SOT-23
(TOP VIEW)

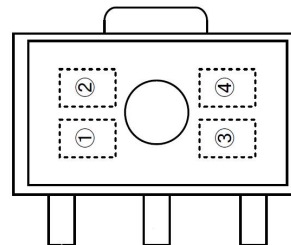

SOT-89
(TOP VIEW)

① represents product number

MARK	PRODUCT SERIES
6	TX6206****

② represents 3 pins regulator

MARK		PRODUCT SERIES
VOLTAGE=0.1~3.0V	VOLTAGE=3.1V~6.0V	
5	6	TX6206

③ represents output voltage

MARK	VOLTAGE(V)			MARK	VOLTAGE(V)		
0	-	3.1	-	F	1.6	4.6	-
1	-	3.2	-	H	1.7	4.7	-
2	-	3.3	-	K	1.8	4.8	-
3	-	3.4	-	L	1.9	4.9	-
4	-	3.5	-	M	2.0	5.0	-
5	-	3.6	-	N	2.1	-	-
6	-	3.7	-	P	2.2	-	-
7	-	3.8	-	R	2.3	-	-
8	-	3.9	-	S	2.4	-	-
9	-	4.0	-	T	2.5	-	-
A	-	4.1	-	U	2.6	-	-
B	1.2	4.2	-	V	2.7	-	-
C	1.3	4.3	-	X	2.8	-	-
D	1.4	4.4	-	Y	2.9	-	-
E	1.5	4.5	-	Z	3.0	-	-

④ X

**TX6206****300mA Low Power LDO**<http://www.txsemi.com>**Absolute Maximum Ratings**

Parameter	Symbol	Ratings	Units	
Input Voltage	V _{IN}	8	V	
Output Current	I _{OUT}	300*	mA	
Output Voltage	V _{OUT}	V _{SS} -0.3~V _{IN} +0.3	V	
Power Dissipation	SOT-23	P _d	0.20	W
	SOT23-3		0.25	W
	SOT-89		0.50	W
	USP-6B		0.10	W
	TO-92		0.50	W
Operating Temperature Range	T _{opr}	-40~+85	°C	
Storage Temperature Range	T _{stg}	-55~+125	°C	

*I_{OUT}=P_d/(V_{IN}-V_{OUT})

Electrical Characteristics

TX6206 for any output voltage

(Ta=25°C)

Parameter	Symbol	Conditions	Min.	Typ.	Max.	Unit
Output Voltage	V _{out}	V _{in} =V _{out} +1V 1.0mA≤I _{out} ≤30mA	V _{out} ×0.98	--	V _{out} ×1.02	V
Output Current*1	I _{out}	V _{in} -V _{out} =1V	--	300	--	mA
Low dropout*2	V _{drop}	Refer to the next table				
Line Regulation	ΔV _{out1} /(V _{in} -V _{out})	1.6V≤V _{in} ≤8V I _{out} =40mA	--	0.05	0.2	%/V
Load Regulation	ΔV _{out} /ΔI _{out}	V _{in} =V _{out} +1V 1.0mA≤I _{out} ≤80mA	--	12	30	mV
Output voltage Temperature Coefficiency	ΔV _{out} /(Ta·V _{out})	I _{out} =30mA 0°C≤Ta≤70°C	--	±100	--	Ppm/°C
Supply Current	I _{ss}	--	--	3	5	uA
Input Voltage	V _{in}	--	--	6	8	V
PSRR	PSRR	F=1KHz V _{in} =V _{out} +1V	--	50	--	dB
Output Noise	EN	BW=10Hz~100KHz	--	30	--	uVrms



Electrical Characteristics by Output Voltage:

Output Voltage Vout(V)	Dropout Voltage Vdif (V)		
	Conditions	Typ.	Max.
Vout≤1.5V	Iout=100 mA	0.35	0.57
1.8 ≤ Vout ≤ 2		0.28	0.42
2.8 ≤ Vout ≤ 5.0		0.19	0.35

Typical Performance Characteristics

(1) Output Voltage vs Input voltage and Output Voltage vs. Output Current and Input Transient Response

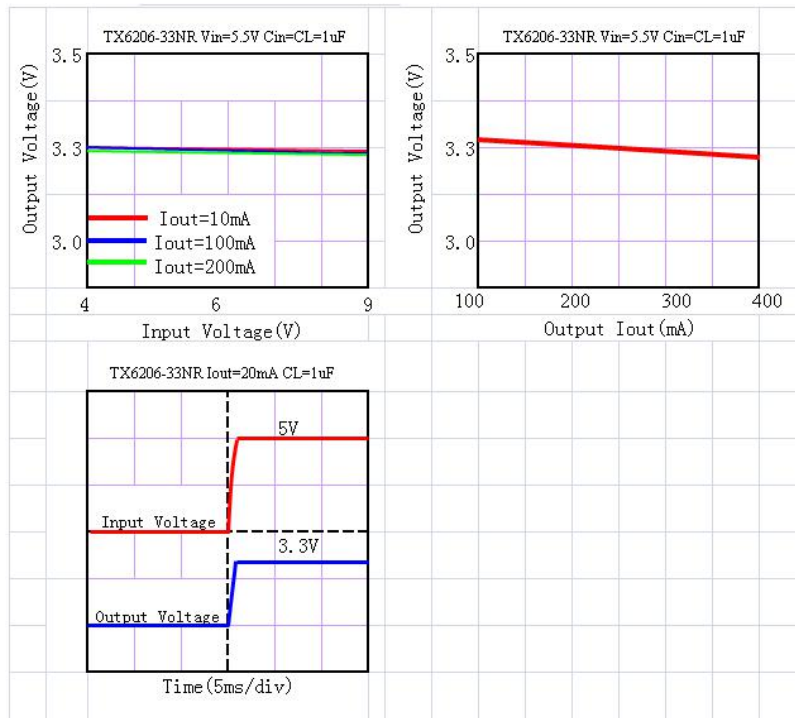

(2) Output Voltage vs. Ambient Temperature

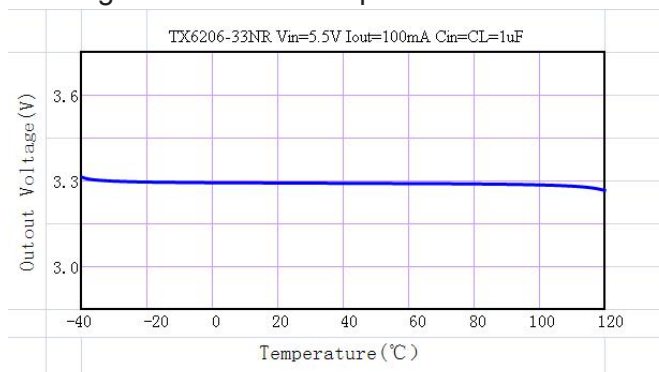



Package Information

3-pin SOT23 Outline Dimensions

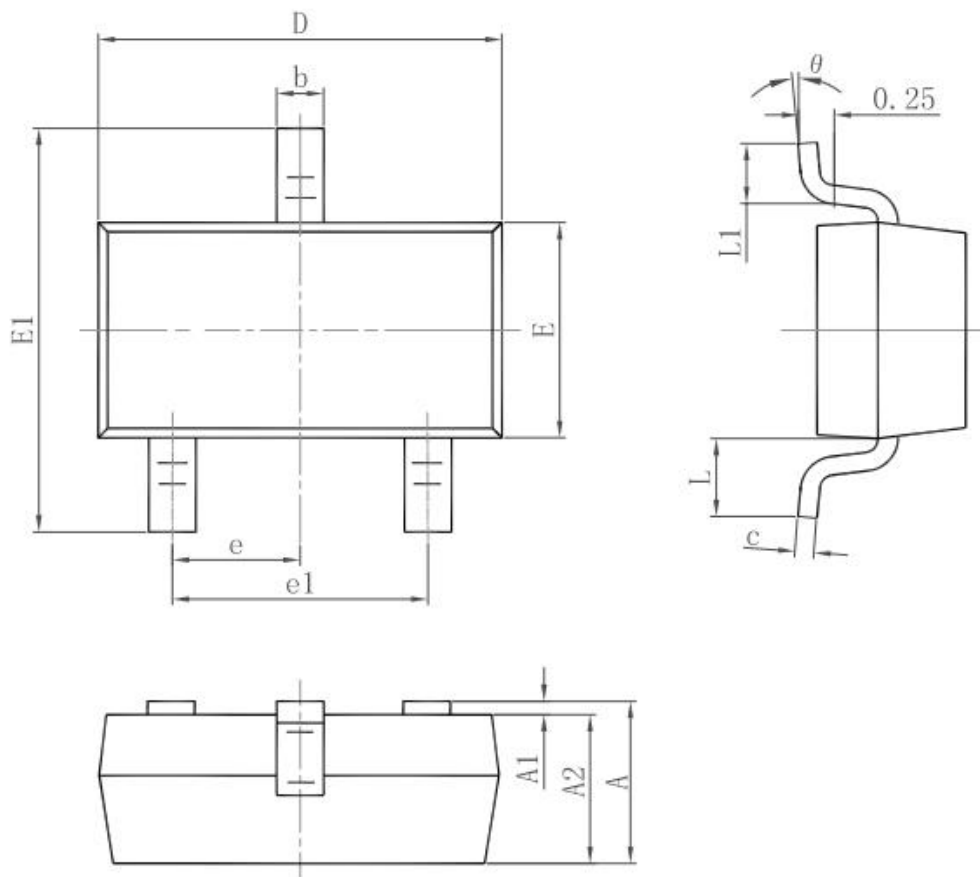

Symbol	Dimensions In Millimeters		Dimensions In Inches	
	Min.	Max.	Min.	Max.
A	0.900	1.150	0.035	0.045
A1	0.000	0.100	0.000	0.004
A2	0.900	1.050	0.035	0.041
b	0.300	0.500	0.012	0.020
c	0.080	0.150	0.003	0.006
D	2.800	3.000	0.110	0.118
E	1.200	1.400	0.047	0.055
E1	2.250	2.550	0.089	0.100
e	0.950 TYP.		0.037 TYP.	
e1	1.800	2.000	0.071	0.079
L	0.550 REF.		0.022 REF.	
L1	0.300	0.500	0.012	0.020
θ	0°	8°	0°	8°



3-pin SOT23-3 Outline Dimensions

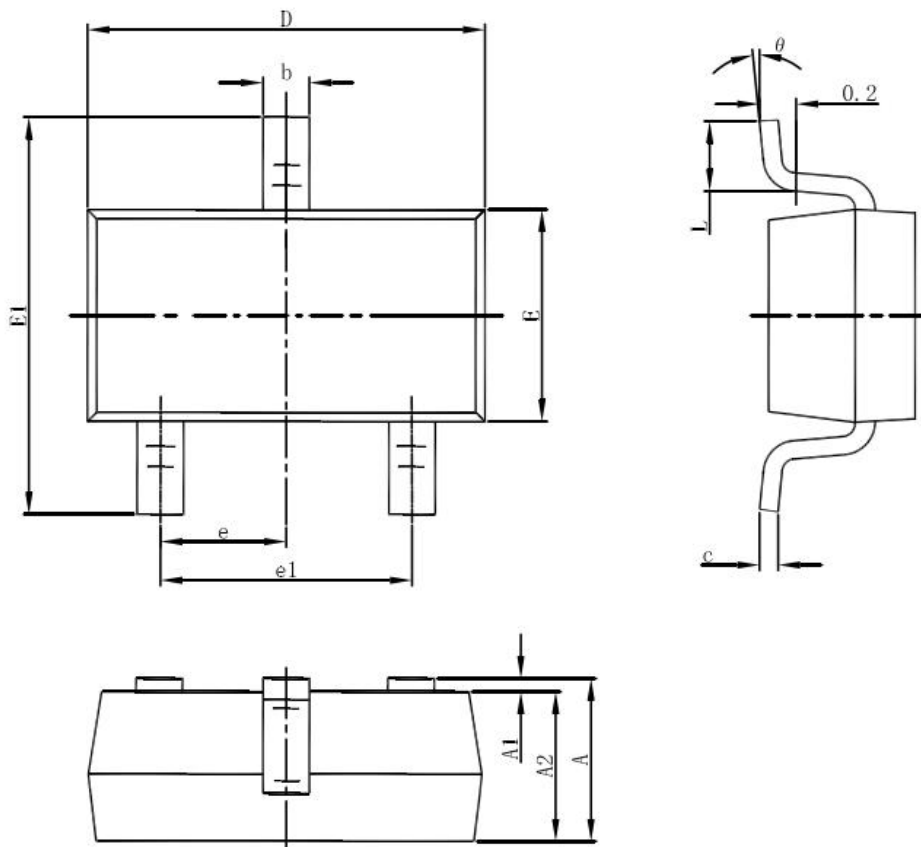

Symbol	Dimensions In Millimeters		Dimensions In Inches	
	Min	Max	Min	Max
A	1.050	1.250	0.041	0.049
A1	0.000	0.100	0.000	0.004
A2	1.050	1.150	0.041	0.045
b	0.300	0.500	0.012	0.020
c	0.100	0.200	0.004	0.008
D	2.820	3.020	0.111	0.119
E	1.500	1.700	0.059	0.067
E1	2.650	2.950	0.104	0.116
e	0.950(BSC)		0.037(BSC)	
e1	1.800	2.000	0.071	0.079
L	0.300	0.600	0.012	0.024
theta	0°	8°	0°	8°



TX6206

<http://www.txsemi.com>

300mA Low Power LDO

3-pin SOT89 Outline Dimensions

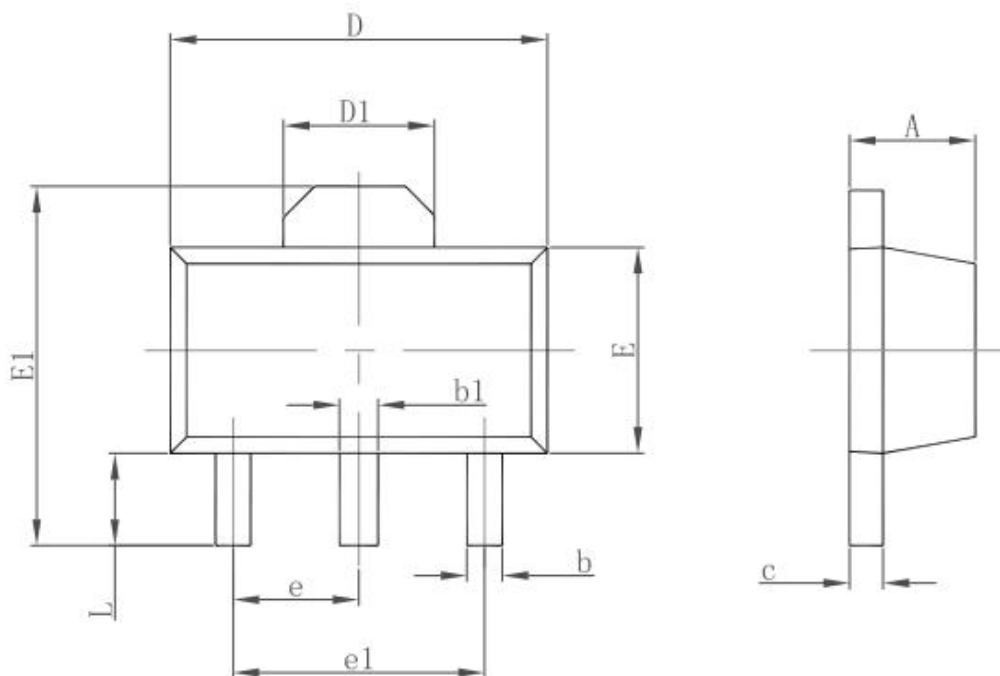

Symbol	Dimensions In Millimeters		Dimensions In Inches	
	Min.	Max.	Min.	Max.
A	1.400	1.600	0.055	0.063
b	0.320	0.520	0.013	0.020
b1	0.400	0.580	0.016	0.023
c	0.350	0.440	0.014	0.017
D	4.400	4.600	0.173	0.181
D1	1.550 REF.		0.061 REF.	
E	2.300	2.600	0.091	0.102
E1	3.940	4.250	0.155	0.167
e	1.500 TYP.		0.060 TYP.	
e1	3.000 TYP.		0.118 TYP.	
L	0.900	1.200	0.035	0.047



<http://www.txsemi.com>

TX6206

300mA Low Power LDO

© Shanghai TX Electronics Sci-Tech Co., Ltd

TX cannot assume responsibility for use of any circuitry other than circuitry entirely embodied in a TX product. No circuit patent license, copyrights or other intellectual property rights are implied. TX reserves the right to make changes to their products or specifications without notice. Customers are advised to obtain the latest version of relevant information to verify, before placing orders, that information being relied on is current and complete.