



<http://www.txsemi.com>

# TX6216

## 300mA Low Power LDO

### Features

- Low power consumption
- Low voltage drop
- Low temperature coefficient
- Low Quiescent Current: 5uA at 6V
- Output voltage accuracy: tolerance  $\pm 2\%$

### Applications

- Battery-powered equipment
- Reference voltage sources
- Cameras, video cameras
- Portable AV systems
- Mobile phones
- Portable games

### General Description

TX6216 series are a highly precise, lower consumption, 3 terminal, positive voltage regulators manufactured using CMOS and laser trimming technologies. The series provides large currents with a significantly small dropout voltage .

The TX6216 consists of a current limiter circuit, a driver transistor, a precision reference voltage and an error correction circuit. The series is

compatible with low ESR ceramic capacitors. The current limiter's foldback circuit operates as a short circuit protection as well as the output current limiter for the output pin. Output voltages are internally by laser trimming technologies. It is selectable in 0.1V increments within a range of 1.2V to 3.6V. TX6216 series are available in SOT-23 、SOT23-3and SOT-89 packages.

### Order Information

TX6216-①②③④⑤

Designator	Symbol	Description
①②	Integer	Output Voltage(1.2~3.6V)
③	--	Normal
	G	Standard
④	N	Package:SOT23
	M	Package:SOT23-3
	P	Package:SOT89
⑤	R	RoHS / Pb Free
	G	Halogen Free

Note:"①②" stands for output voltages. Other voltages can be specially customized



**Block Diagram**

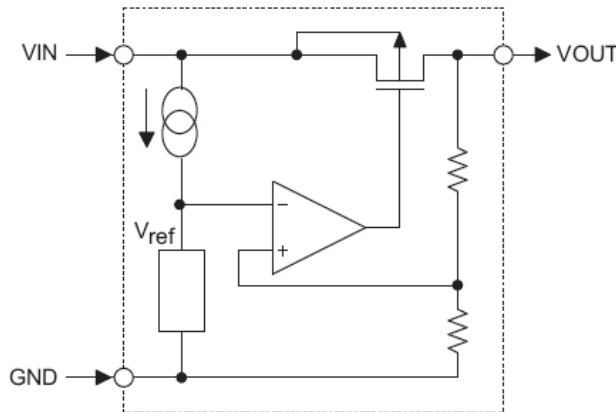

**Pin Assignment**

SOT23 and SOT23-3 (Top View)

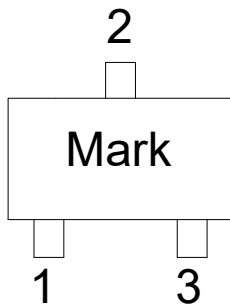

Table1: TX6216-XXNR/TX6216-XXMR series (SOT23/SOT23-3 PKG)

PIN NO.	PIN NAME	FUNCTION
1	GND	GND pin
2	VIN	Input voltage pin
3	VOUT	Output voltage pin

SOT89 (Top View)

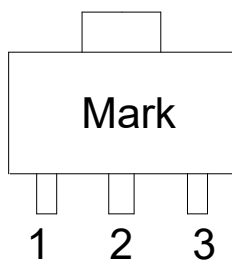

Table2: TX6216-XXPR series (SOT89 PKG)

PIN NO.	PIN NAME	FUNCTION
1	GND	GND pin
2	VIN	Input voltage pin
3	VOUT	Output voltage pin



<http://www.txsemi.com>

# TX6216

## 300mA Low Power LDO

### Marking Rule

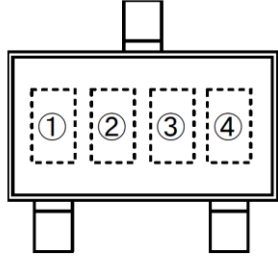

SOT-23  
(TOP VIEW)

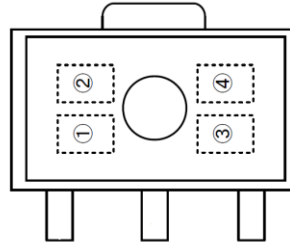

SOT-89  
(TOP VIEW)

Product Name	Product Code			
	(1)	(2)	(3)	(4)
TX6216-15	6	5	E	9
TX6216-18	6	5	K	5
TX6216-25	6	5	T	5
TX6216-28	5	4	F	K
TX6216-30	6	5	Z	5
TX6216-33	6	6	2	K
TX6216-36	6	6	5	K



**TX6216**

**300mA Low Power LDO**

<http://www.txsemi.com>

**Absolute Maximum Ratings**

Parameter		Symbol	Ratings	Units
Input Voltage		V <sub>IN</sub>	8	V
Output Current		I <sub>OUT</sub>	300*	mA
Output Voltage		V <sub>OUT</sub>	V <sub>SS</sub> -0.3~V <sub>IN</sub> +0.3	V
Power Dissipation	SOT-23	P <sub>d</sub>	0.20	W
	SOT23-3		0.25	W
	SOT-89		0.50	W
Operating Temperature Range		T <sub>opr</sub>	-40~+85	°C
Storage Temperature Range		T <sub>stg</sub>	-55~+125	°C

\*I<sub>OUT</sub>=P<sub>d</sub>/(V<sub>IN</sub>-V<sub>OUT</sub>)

**Electrical Characteristics**

TX6216 for any output voltage

(T<sub>a</sub>=25°C)

Parameter	Symbol	Conditions	Min.	Typ.	Max.	Unit
Output Voltage	V <sub>out</sub>	V <sub>in</sub> =V <sub>out</sub> +1V 1.0mA≤I <sub>out</sub> ≤30mA	V <sub>out</sub> ×0.98	--	V <sub>out</sub> ×1.02	V
Output Current*1	I <sub>out</sub>	V <sub>in</sub> -V <sub>out</sub> =1V	--	300	--	mA
Low dropout*2	V <sub>drop</sub>	Refer to the next table				
Line Regulation	Δ V <sub>out</sub> 1/(V <sub>in</sub> -V <sub>out</sub> )	1.6V≤V <sub>in</sub> ≤8V I <sub>out</sub> =40mA	--	0.05	0.2	%/V
Load Regulation	Δ V <sub>out</sub> /ΔI <sub>out</sub>	V <sub>in</sub> = V <sub>out</sub> +1V 1.0mA≤I <sub>out</sub> ≤80mA	--	12	30	mV
Output voltage Temperature coefficient	Δ V <sub>out</sub> /(T <sub>a</sub> -V <sub>out</sub> )	I <sub>out</sub> =30mA 0°C≤T <sub>a</sub> ≤70°C	--	±100	--	Ppm/°C
Supply Current	I <sub>ss</sub>	V <sub>in</sub> =6V	--	5	10	uA
Input Voltage	V <sub>in</sub>	--	--	6	8	V
PSRR	PSRR	F=1KHz V <sub>in</sub> =V <sub>out</sub> +1V	--	50	--	dB

**Electrical Characteristics by Output Voltage:**

Output Voltage V <sub>out</sub> (V)	Dropout Voltage V <sub>dif</sub> (V)		
	Conditions	Typ.	Max.
V <sub>out</sub> ≤1.5V	I <sub>out</sub> =100 mA	0.50	0.68
1.8 ≤ V <sub>out</sub> ≤ 2		0.39	0.53
2.8 ≤ V <sub>out</sub> ≤ 5.0		0.23	0.39



### Package Information

#### 3-pin SOT23 Outline Dimensions

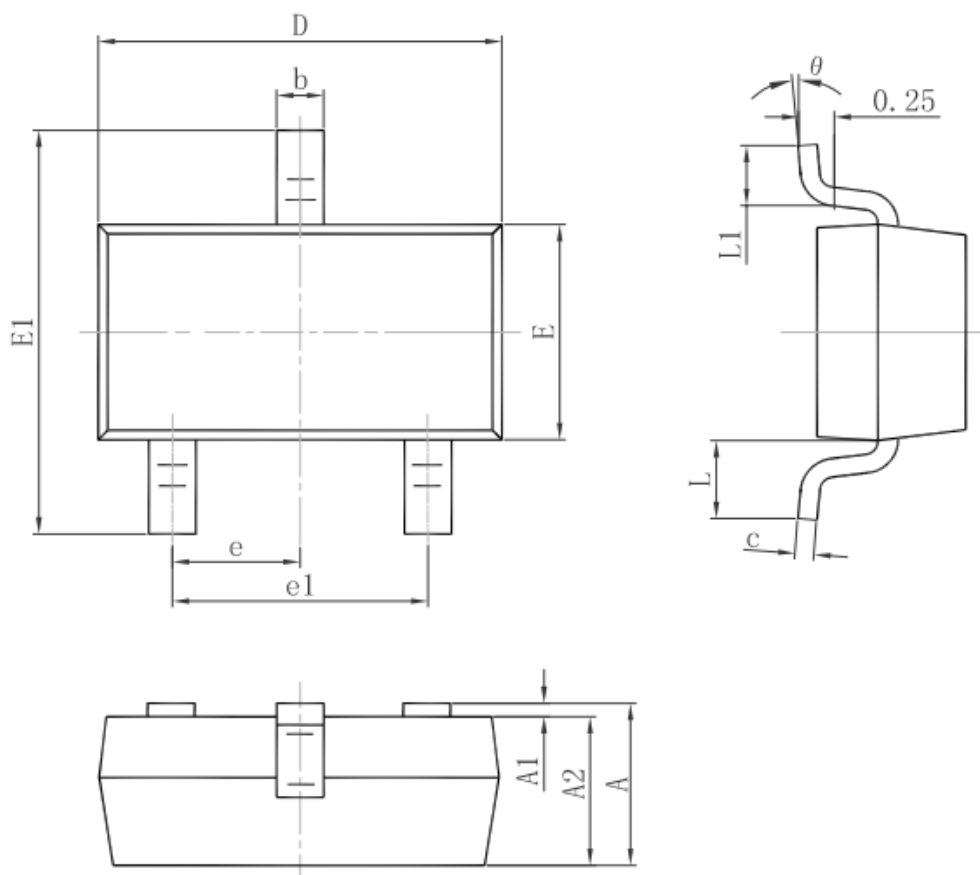

Symbol	Dimensions In Millimeters		Dimensions In Inches	
	Min.	Max.	Min.	Max.
A	0.900	1.150	0.035	0.045
A1	0.000	0.100	0.000	0.004
A2	0.900	1.050	0.035	0.041
b	0.300	0.500	0.012	0.020
c	0.080	0.150	0.003	0.006
D	2.800	3.000	0.110	0.118
E	1.200	1.400	0.047	0.055
E1	2.250	2.550	0.089	0.100
e	0.950 TYP.		0.037 TYP.	
e1	1.800	2.000	0.071	0.079
L	0.550 REF.		0.022 REF.	
L1	0.300	0.500	0.012	0.020
theta	0°	8°	0°	8°



**3-pin SOT23-3 Outline Dimensions**

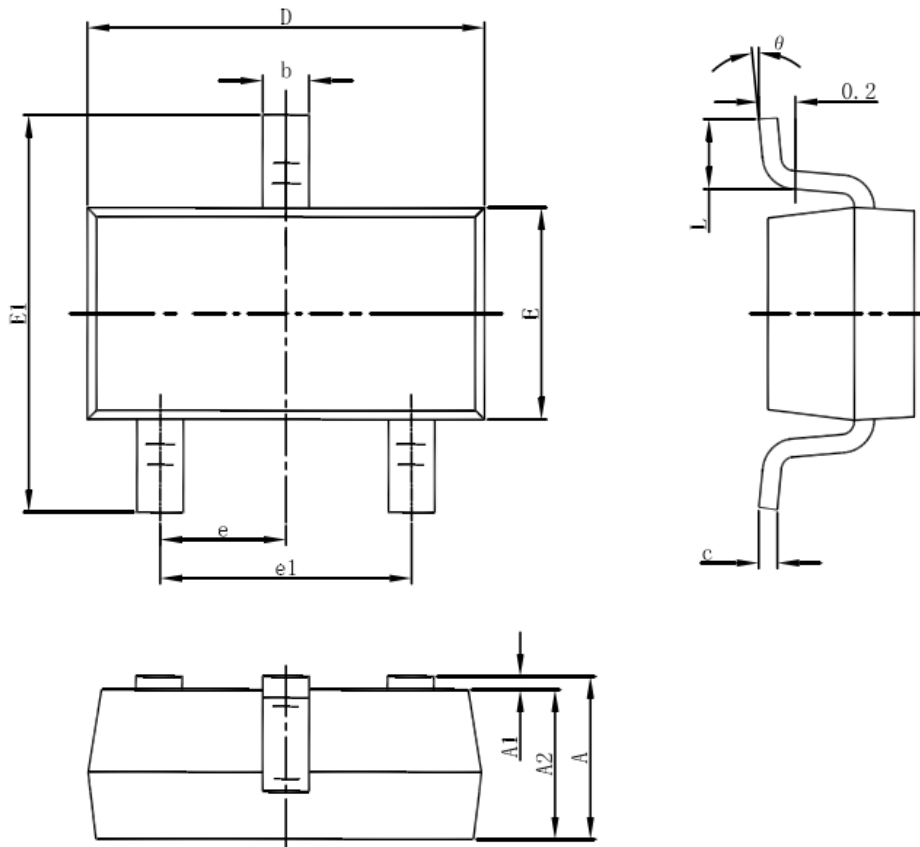

Symbol	Dimensions In Millimeters		Dimensions In Inches	
	Min	Max	Min	Max
A	1.050	1.250	0.041	0.049
A1	0.000	0.100	0.000	0.004
A2	1.050	1.150	0.041	0.045
b	0.300	0.500	0.012	0.020
c	0.100	0.200	0.004	0.008
D	2.820	3.020	0.111	0.119
E	1.500	1.700	0.059	0.067
E1	2.650	2.950	0.104	0.116
e	0.950(BSC)		0.037(BSC)	
e1	1.800	2.000	0.071	0.079
L	0.300	0.600	0.012	0.024
theta	0°	8°	0°	8°



**TX6216**

<http://www.txsemi.com>

**300mA Low Power LDO**

**3-pin SOT89 Outline Dimensions**

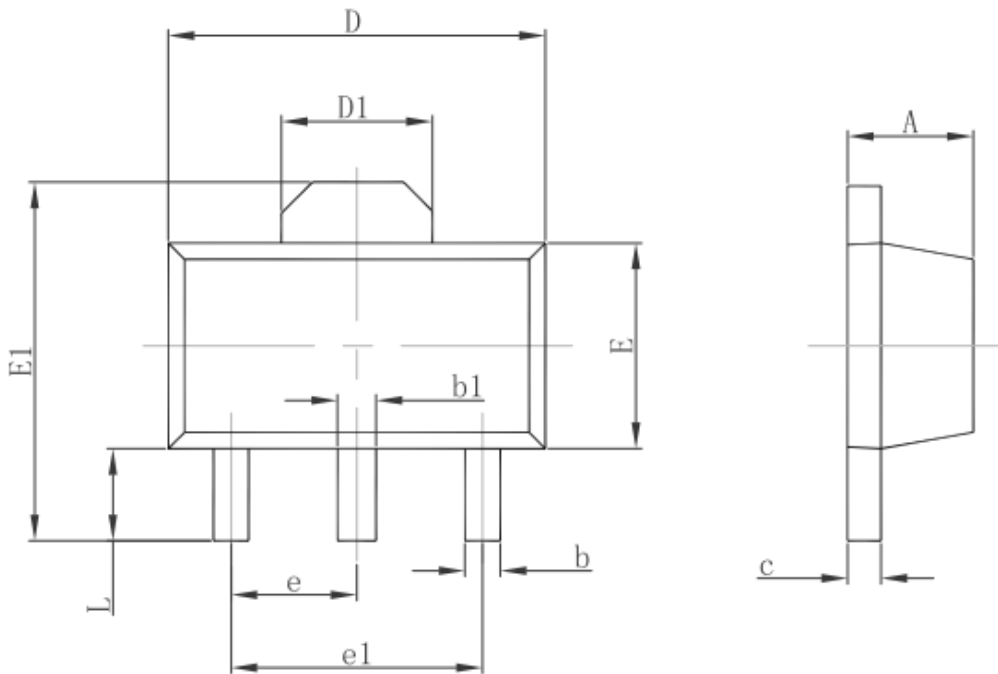

Symbol	Dimensions In Millimeters		Dimensions In Inches	
	Min.	Max.	Min.	Max.
A	1.400	1.600	0.055	0.063
b	0.320	0.520	0.013	0.020
b1	0.400	0.580	0.016	0.023
c	0.350	0.440	0.014	0.017
D	4.400	4.600	0.173	0.181
D1	1.550 REF.		0.061 REF.	
E	2.300	2.600	0.091	0.102
E1	3.940	4.250	0.155	0.167
e	1.500 TYP.		0.060 TYP.	
e1	3.000 TYP.		0.118 TYP.	
L	0.900	1.200	0.035	0.047



<http://www.txsemi.com>

# **TX6216**

## **300mA Low Power LDO**

---

© Shanghai TX Electronics Sci-Tech Co., Ltd

TX cannot assume responsibility for use of any circuitry other than circuitry entirely embodied in a TX product. No circuit patent license, copyrights or other intellectual property rights are implied. TX reserves the right to make changes to their products or specifications without notice. Customers are advised to obtain the latest version of relevant information to verify, before placing orders, that information being relied on is current and complete.