



TX6251

1A Low Power LDO

Features

- Low voltage drop: 0.06V@100mA
- High input voltage: 8.5V
- Low temperature coefficient
- Low Quiescent Current: 2uA at 5.0V
- Output voltage accuracy: tolerance $\pm 2\%$

Applications

- Battery-powered equipment
- Hand-Hold Equipment
- GRS Receivers
- Wireless LAN

General Description

The TX6251 series is a group of positive voltage output, three-pin regulators that provide a high current even when the input/output voltage differential is small. Low power consumption and high accuracy is achieved through CMOS and laser trimming technologies.

The TX6251 consists of a high-precision

voltage reference, an error amplification circuit, and a current limited output driver. Transient response to a load variations have improved in comparison to the existing series.

SOT89-3 and SOT23-5 packages are available.

Order Information

TX6251①②③④

Designator	Symbol	Description
①	P	Package:SOT89A
	PB	Package:SOT89B
	M5	Package:SOT23-5
②③	Integer	Output Voltage(1.2~5.0V)
④	R	RoHS / Pb Free
	G	Halogen Free

Typical Application

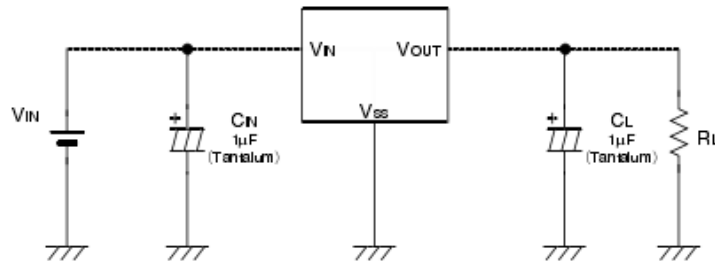

Note1: Input capacitor $C_{IN}=1\mu F$.

Note2: Output capacitor $C_{OUT}=1\mu F/6.8\mu F$ (1uF Tantalum capacitor or 6.8uF ceramic capacitor is recommended).



Block Diagram

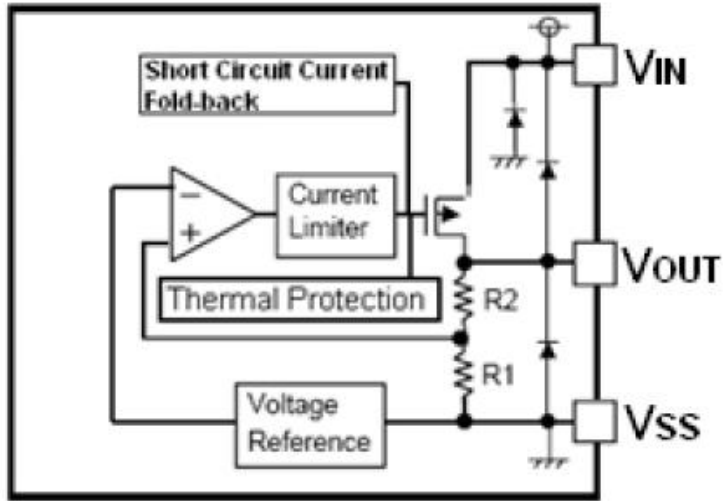



TX6251 1A Low Power LDO

Pin Assignment

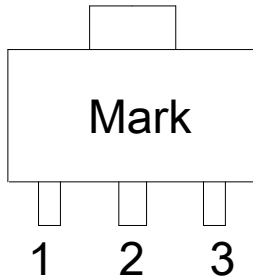

Table1 TX6251 series (SOT89A PKG)

PIN NO.	PIN NAME	FUNCTION
1	GND	GND pin
2	VIN	Input voltage pin
3	VOUT	Output voltage pin

Table2 TX6251 series (SOT89B PKG)

PIN NO.	PIN NAME	FUNCTION
1	VIN	Input voltage pin
2	GND	GND pin
3	VOUT	Output voltage pin

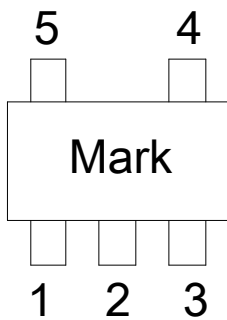
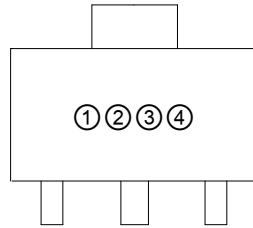

Table3 TX6251 series (SOT23-5 PKG)

PIN NO.	PIN NAME	FUNCTION
1	VIN	Input voltage pin
2	GND	GND pin
3	EN	Enable pin "H": Normal operation "L": Step-up stopped
4	NC	(N.C.)
5	VOUT	Output voltage pin



Marking Rule
SOT89-3



① represents the integer of the output voltage

SYMBOL	VOLTAGE(V)
1	1.②
2	2.②
3	3.②
4	4.②
5	5.②
6	6.②

② represents the decimal number of the output voltage

SYMBOL	VOLTAGE(V)	SYMBOL	VOLTAGE(V)
A	①. 0	F	①. 5
B	①. 1	H	①. 6
C	①. 2	K	①. 7
D	①. 3	L	①. 8
E	①. 4	M	①. 9

③ based on internal standards

SYMBOL
0

④ represents the assembly LOT No.
Based on internal standards



SOT23-5

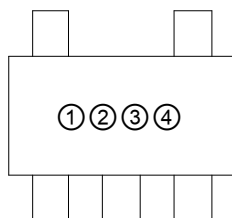

① product code: G

② output voltage code:

Voltage(V)	Code	Voltage(V)	Code	Voltage(V)	Code
1.0	a	2.4	0	3.8	N
1.1	b	2.5	A	3.9	O
1.2	c	2.6	B	4.0	P
1.3	d	2.7	C	4.1	Q
1.4	e	2.8	D	4.2	R
1.5	1	2.9	E	4.3	S
1.6	2	3.0	F	4.4	T
1.7	3	3.1	G	4.5	U
1.8	4	3.2	H	4.6	V
1.9	5	3.3	I	4.7	W
2.0	6	3.4	J	4.8	X
2.1	7	3.5	K	4.9	Y
2.2	8	3.6	L	5.0	Z
2.3	9	3.7	M		

③ CE code

Symbol	Standard
E	With CE
N	Without CE

④ Data Code: X



<http://www.txsemi.com>

TX6251

1A Low Power LDO

Absolute Maximum Ratings

Supply Voltage-0.3V to 8.5V Operating Temperature-40°C to 85°C
 Output Current.....1.1A Storage Temperature-40°C to 125°C

Note: These are stress ratings only. Stresses exceeding the range specified under “Absolute Maximum Ratings” may cause substantial damage to the device. Functional operation of this device at other conditions beyond those listed in the specification is not implied and prolonged exposure to extreme conditions may affect device reliability.

Electrical Characteristics

TX6251 for any output voltage

(Ta=25°C)

Symbol	Parameter	Conditions	Min.	Typ.	Max.	Unit
V _{OUT}	Output Voltage	V _{in} =V _{out} +1V 1.0mA≤I _{out} ≤30mA	V _{out} ×0.98	--	V _{out} ×1.02	V
I _{OUT}	Output Current*1	V _{in} -V _{out} =1V	--	1000	--	mA
V _{DROP}	Low dropout*2	Refer to the next table				
$\frac{\Delta V_{OUT}}{\Delta V_{IN} \times V_{OUT}}$	Line Regulation	1.6V≤V _{in} ≤8V I _{out} =100mA	--	0.05	0.2	%/V
$\Delta V_{OUT} / \Delta I_{OUT}$	ΔV _{out} / ΔI _{out}	V _{in} = V _{out} +1V 1.0mA≤I _{out} ≤100mA	--	12	30	mV
Output voltage Temperature Coefficiency	ΔV _{out} /(Ta·V _{out})	I _{out} =30mA 0°C≤Ta≤70°C	--	±100	--	Ppm/°C
Supply Current	I _{ss}	--	--	2	5	uA
Input Voltage	V _{in}	--	--	--	8.5	V

Electrical Characteristics by Output Voltage:

Output Voltage V _{out} (V)	Dropout Voltage V _{dif} (V)		
	Conditions	Typ.	Max.
V _{out} ≤ 2.0V	I _{out} =60 mA	0.05	0.08
2.0 < V _{out} ≤ 3.0	I _{out} =80 mA	0.05	0.08
3.0 < V _{out} ≤ 4.0	I _{out} =100 mA	0.06	0.08
4.0 < V _{out} ≤ 5.0		0.05	0.08
3.0 < V _{out} ≤ 4.0	I _{out} =200 mA	0.13	0.16
4.0 < V _{out} ≤ 5.0		0.12	0.16
3.0 < V _{out} ≤ 4.0	I _{out} =1000 mA	0.65	0.8
4.0 < V _{out} ≤ 5.0		0.6	0.8



<http://www.txsemi.com>

TX6251

1A Low Power LDO

Package Information

3-pin SOT89 Outline Dimensions

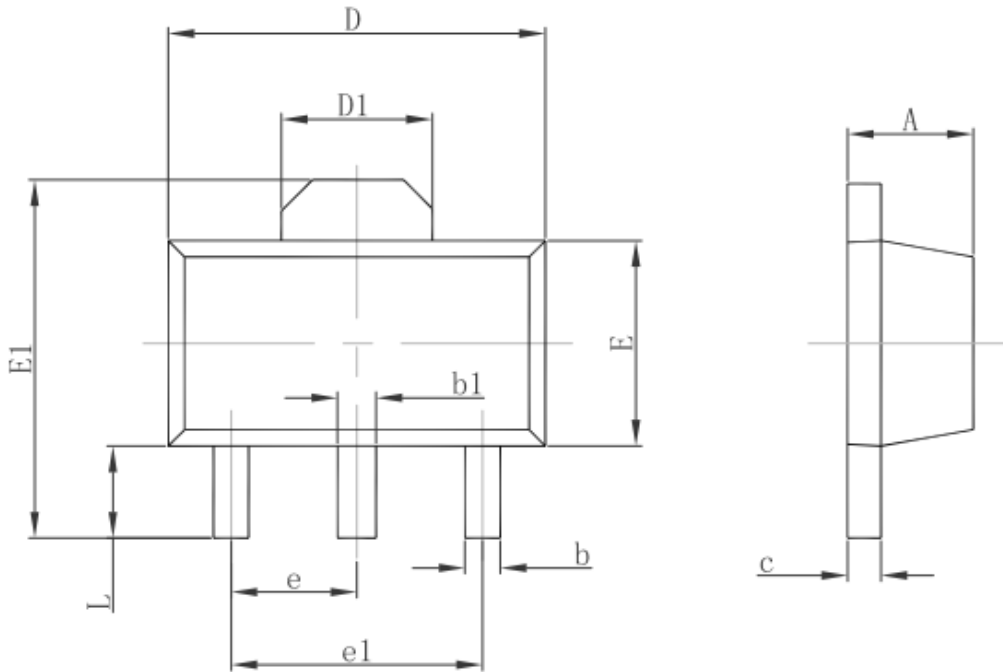

Symbol	Dimensions In Millimeters		Dimensions In Inches	
	Min.	Max.	Min.	Max.
A	1.400	1.600	0.055	0.063
b	0.320	0.520	0.013	0.020
b1	0.400	0.580	0.016	0.023
c	0.350	0.440	0.014	0.017
D	4.400	4.600	0.173	0.181
D1	1.550 REF.		0.061 REF.	
E	2.300	2.600	0.091	0.102
E1	3.940	4.250	0.155	0.167
e	1.500 TYP.		0.060 TYP.	
e1	3.000 TYP.		0.118 TYP.	
L	0.900	1.200	0.035	0.047



<http://www.txsemi.com>

TX6251 1A Low Power LDO

SOT23-5 Outline Dimensions

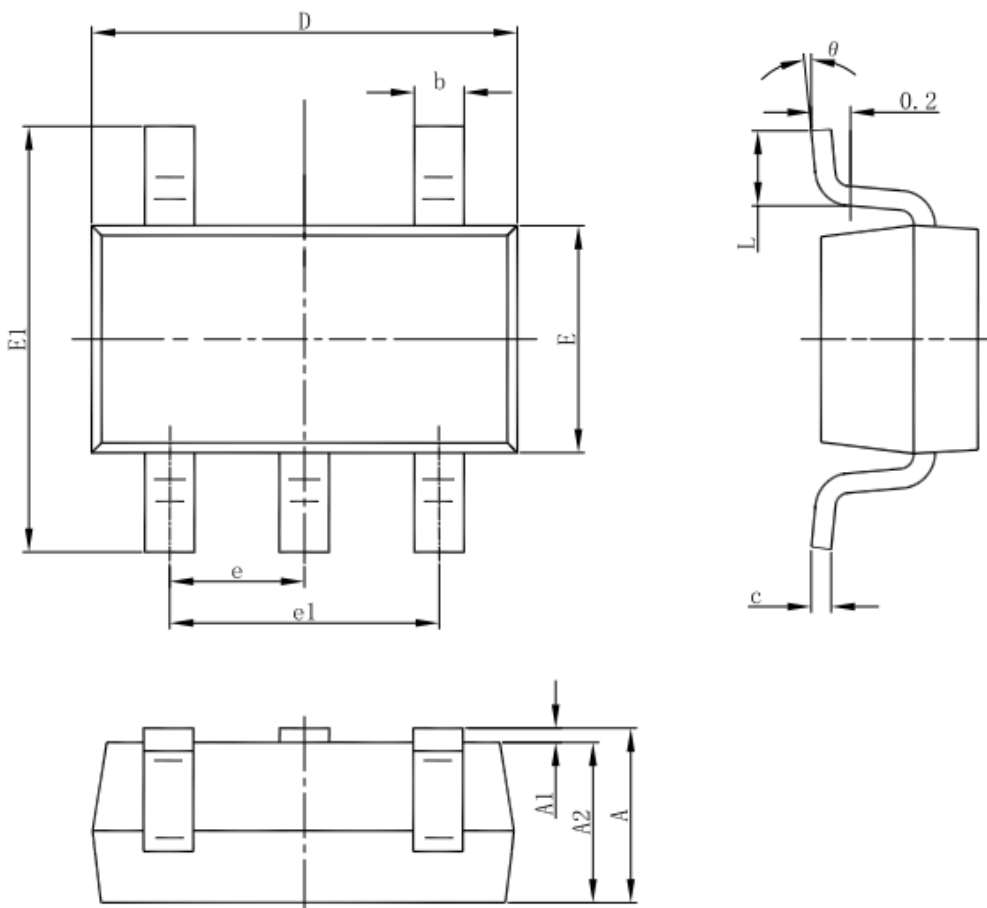

Symbol	Dimensions In Millimeters		Dimensions In Inches	
	Min	Max	Min	Max
A	1.050	1.250	0.041	0.049
A1	0.000	0.100	0.000	0.004
A2	1.050	1.150	0.041	0.045
b	0.300	0.500	0.012	0.020
c	0.100	0.200	0.004	0.008
D	2.820	3.020	0.111	0.119
E	1.500	1.700	0.059	0.067
E1	2.650	2.950	0.104	0.116
e	0.950(BSC)		0.037(BSC)	
e1	1.800	2.000	0.071	0.079
L	0.300	0.600	0.012	0.024
θ	0°	8°	0°	8°



<http://www.txsemi.com>

TX6251

1A Low Power LDO

© Shanghai TX Electronics Sci-Tech Co., Ltd

TX cannot assume responsibility for use of any circuitry other than circuitry entirely embodied in a TX product. No circuit patent license, copyrights or other intellectual property rights are implied. TX reserves the right to make changes to their products or specifications without notice. Customers are advised to obtain the latest version of relevant information to verify, before placing orders, that information being relied on is current and complete.