



<http://www.txsemi.com>

TX1117

1A Bipolar Linear Regulator

Features

- Output current is 1A
- Range of operation input voltage: 15V
- Line regulation: 0.03%/V (typ.)
- Standby current: 2mA (typ.)
- Load regulation: 0.2%/A (typ.)
- Environment Temperature: -40°C~125°C

Applications

- Power Management for Computer Mother Board, Graphic Card
- LCD Monitor and LCD TV
- DVD Decode Board
- ADSL Modem
- Post Regulators for Switching Supplies

General Description

TX1117 is a series of low dropout three-terminal regulators with a dropout of 1.1V at 1A load current. TX1117 features a very low standby current 2mA compared to 5mA of competitor.

Other than a fixed version, $V_{out} = 1.2V, 1.5V, 1.8V, 2.5V, 2.85V, 3.3V,$ and $5V,$ TX1117 has an adjustable version, which can provide an output voltage from 1.25 to 12V with only two external resistors.

TX1117 offers thermal shut down function, to assure the stability of chip and power system. And it uses trimming technique to guarantee output voltage accuracy within 2%. Other output voltage accuracy can be customized on demand, such as 1%.

TX1117 is available in SOT-223, TO-252 and SOT89 packages.

Selection Table

Part No.	Symbol.	Output Voltage	Package
TX1117	XX=12	1.2V	SOT89 SOT-223 TO-252
	XX=15	1.5V	
	XX=18	1.8V	
	XX=285	2.85V	
	XX=25	2.5V	
	XX=33	3.3V	
	XX=50	5.0V	
	XX=adj	adj	

Order Information

Part No.	Package Type	Packing type
TX1117PR-XXV	SOT89	1000 Tape&Reel
TX1117-XXV	SOT223	2500 Tape&Reel
TX1117TR-XXV	TO252	2500 Tape&Reel

Note: XX stands for Output Voltage



Block Diagram

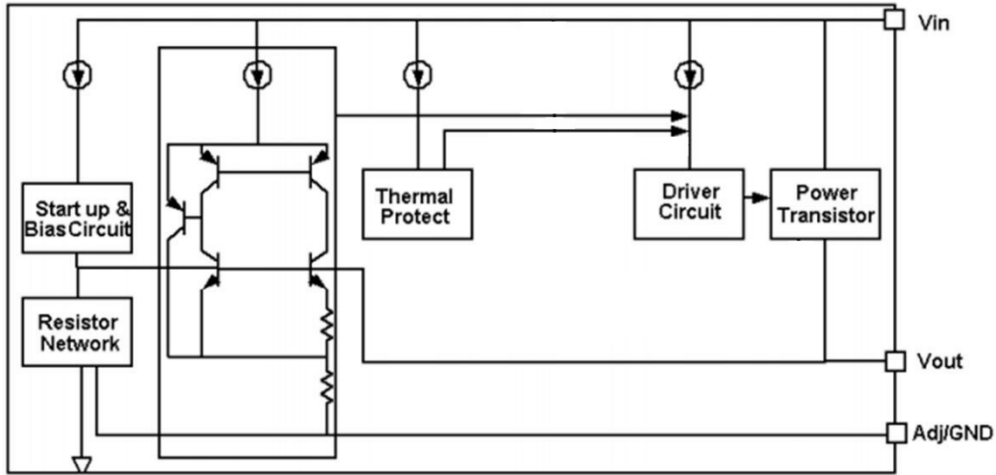

Pin Configuration

SOT223 (Top View)



Table1: TX1117 series (SOT223 PKG)

PIN NO.	PIN NAME	FUNCTION
1	VSS/ADJ	VSS/ADJ pin
2	VOUT	Output voltage pin
3	VIN	Input voltage pin
4	VOUT	Output voltage pin

TO252 (Top View)

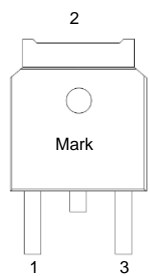

Table2: TX1117 series (TO252 PKG)

PIN NO.	PIN NAME	FUNCTION
1	VSS/ADJ	VSS/ADJ pin
2	VOUT	Output voltage pin
3	VIN	Input voltage pin

SOT89 (Top View)

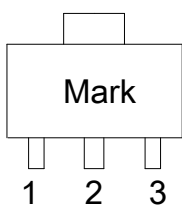

Table3: TX1117 series (SOT89 PKG)

PIN NO.	PIN NAME	FUNCTION
1	VSS/ADJ	VSS/ADJ pin
2	VOUT	Output voltage pin
3	VIN	Input voltage pin



Absolute Maximum Ratings

Max Input Voltage 18V
 Max Operating Junction Temperature(Tj) 150°C
 Operating Temperature(Topr) -40°C~105°C
 Storage Temperature(Ts)..... -55°C~150°C
 Lead Temperature & Time..... 260°C 10S
 Caution: Exceed these limits to damage to the device. Exposure to absolute maximum rating conditions may affect device reliability.

Electrical Characteristics

T_A=25°C, unless otherwise noted.

Symbol	Parameter	Conditions	Min	Typ	Max	Unit
V _{in}	Input voltage		--	15	18	V
V _{ref}	Reference voltage	TX1117-Adj 10mA ≤ I _{out} ≤ 1A, V _{in} =2.55V	1.225	1.25	1.275	V
V _{out}	Output voltage	TX1117-1.2V 0 ≤ I _{out} ≤ 1A, V _{in} =2.5V	1.176	1.2	1.224	V
		TX1117-1.5V 0 ≤ I _{out} ≤ 1A, V _{in} =2.8V	1.47	1.5	1.53	V
		TX1117-1.8V 0 ≤ I _{out} ≤ 1A, V _{in} =3.1V	1.764	1.8	1.836	V
		TX1117-2.5V 0 ≤ I _{out} ≤ 1A, V _{in} =3.8V	2.45	2.5	2.55	V
		TX1117-2.85V 0 ≤ I _{out} ≤ 1A, V _{in} =4.15V	2.793	2.85	2.907	V
		TX1117-3.3V 0 ≤ I _{out} ≤ 1A, V _{in} =4.6V	3.234	3.3	3.366	V
		TX1117-5.0V 0 ≤ I _{out} ≤ 1A, V _{in} =6.3V	4.9	5	5.1	V

ΔV _{out}	Line regulation	TX1117-1.2V I _{out} =10mA, 2.5V ≤ V _{in} ≤ 10V		4	19	mV
		TX1117-1.5V I _{out} =10mA, 2.8V ≤ V _{in} ≤ 10V		5	26	mV
		TX1117-ADJ I _{out} =10mA, 2.55V ≤ V _{in} ≤ 12V		5	24	mV
		TX1117-1.8V I _{out} =10mA, 3.1V ≤ V _{in} ≤ 12V		5	32	mV



<http://www.txsemi.com>

TX1117

1A Bipolar Linear Regulator

		TX1117-2.5V I _{out} =10mA, 3.8V ≤ V _{in} ≤ 12V		8	41	mV
		TX1117-2.85V I _{out} =10mA, 4.15V ≤ V _{in} ≤ 12V		8	46	mV
		TX1117-3.3V I _{out} =10mA, 4.6V ≤ V _{in} ≤ 12V		9	49	mV
		TX1117-5.0V I _{out} =10mA, 6.3V ≤ V _{in} ≤ 12V		10	56	mV

ΔV _{out}	Load regulation	TX1117-1.2V V _{in} =2.5V, 10mA ≤ I _{out} ≤ 1A		10	40	mV
		TX1117-1.5V V _{in} =2.8V, 10mA ≤ I _{out} ≤ 1A		10	40	mV
		TX1117-ADJ V _{in} =2.55V, 10mA ≤ I _{out} ≤ 1A		10	40	mV
		TX1117-1.8V V _{in} =3.1V, 10mA ≤ I _{out} ≤ 1A		10	40	mV
		TX1117-2.5V V _{in} =2.8V, 10mA ≤ I _{out} ≤ 1A		10	40	mV
		TX1117-2.85V V _{in} =4.15V, 10mA ≤ I _{out} ≤ 1A		10	40	mV
		TX1117-3.3 V _{in} =4.6V, 10mA ≤ I _{out} ≤ 1A		10	40	mV
		TX1117-5.0 V _{in} =6.3V, 10mA ≤ I _{out} ≤ 1A		10	40	mV
V _{drop}	Dropout voltage	I _{out} =100mA		1.05	1.2	V
		I _{out} =1A		1.1	1.3	V
I _{min}	Minimum load current	TX1117-ADJ		2	10	mA
I _q	Quiescent Current	TX1117-1.2V, V _{in} =10V		2	5	mA
		TX1117-1.5V, V _{in} =10V		2	5	mA
		TX1117-1.8V, V _{in} =12V		2	5	mA
		TX1117-2.5V, V _{in} =12V		2	5	mA
		TX1117-2.85V, V _{in} =12V		2	5	mA
		TX1117-3.3V, V _{in} =12V		2	5	mA
		TX1117-5.0V, V _{in} =12V		2	5	mA
I _{adj}	Adjust pin current	TX1117-ADJ V _{in} =5V, 10mA ≤ I _{out} ≤ 1A		55	120	μA
I _{change}	I _{adj} change	TX1117-ADJ		0.2	10	μA



<http://www.txsemi.com>

TX1117 1A Bipolar Linear Regulator

		$V_{in}=5V, 10mA \leq I_{out} \leq 1A$			
ΔV_{out}	Temperature coefficient	$V_{in}=4.5V, I_{out}=10mA$ $V_{OUT}=3.3V$ $20^{\circ}C \leq T_a \leq 120^{\circ}C$		30	mV
PSRR		$F=1KHz$		63	dB
θ_{JC}	Thermal resistance	SOT-223		20	$^{\circ}C/W$
		TO-252		10	

Note1: All test are conducted under ambient temperature $25^{\circ}C$ and within a short period of time 20ms

Note2: Load current smaller than minimum load current of TX1117-ADJ will lead to unstable or oscillation output.

Detailed Description

TX1117 is a series of low dropout voltage, three terminal regulators. Its application circuit is very simple: the fixed version only needs two capacitors and the adjustable version only needs two resistors and two capacitors to work. It is composed of some modules including start-up circuit, bias circuit, bandgap, thermal shutdown, power transistors and its driver circuit and so on.

The thermal shut down modules can assure chip and its application system working safety when the temperature is larger than $200^{\circ}C$.

The bandgap module provides stable reference voltage, whose temperature coefficient is compensated by careful design considerations. The temperature coefficient is under $100 \text{ ppm}/^{\circ}C$. And the accuracy of output voltage is guaranteed by trimming technique.

Typical Application

TX1117 has an adjustable version and six fixed versions (1.2V, 1.5V, 1.8V, 2.5V, 2.85V, 3.3V and 5V)

Fixed Output Voltage Version

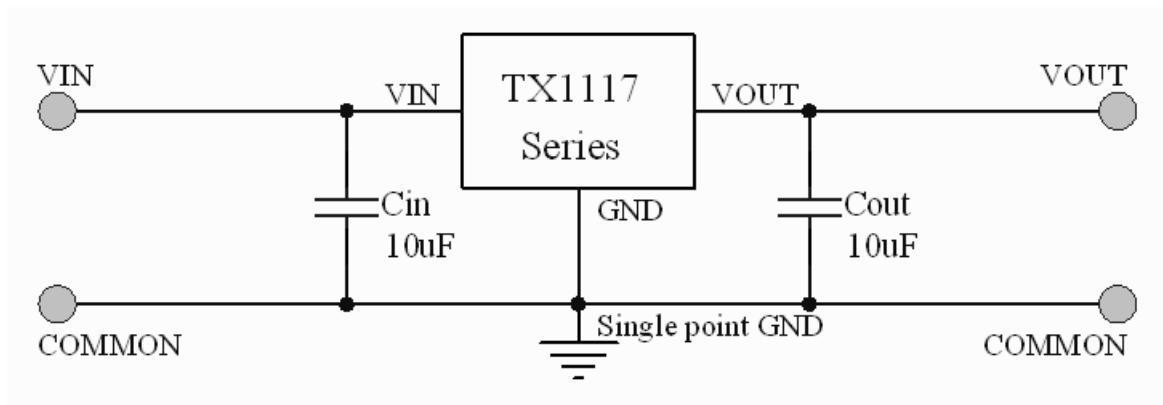

Application circuit of TX1117 fixed version

- 1) Recommend using 10uF tan capacitor as bypass capacitor (C1) for all application circuit.
- 2) Recommend using 10uF tan capacitor to assure circuit stability.



Adjustable Output Voltage Version

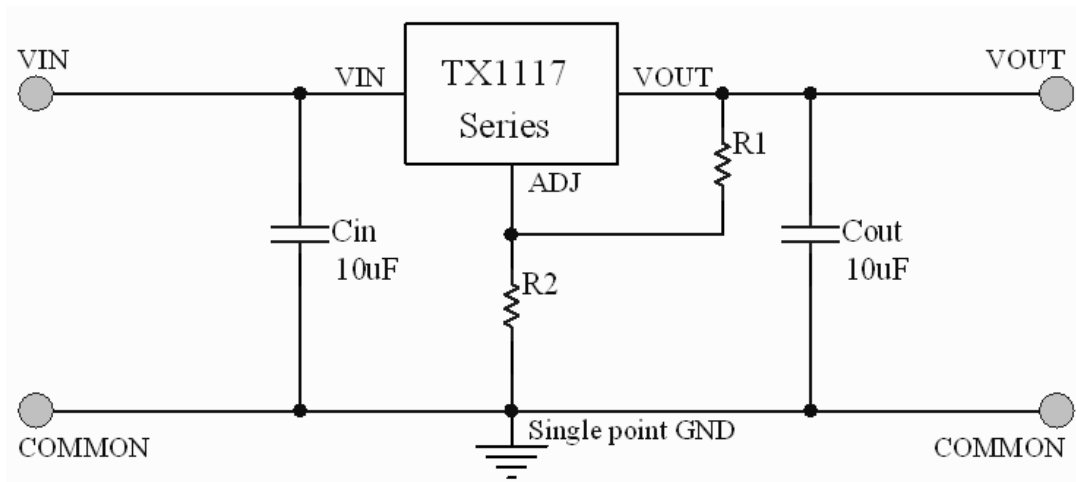

Application Circuit of TX1117-ADJ

The output voltage of adjustable version follows the equation: $V_{out} = 1.25 \times (1 + R_2/R_1) + I_{Adj} \times R_2$. We can ignore I_{Adj} because I_{Adj} (about 50uA) is much less than the current of R_1 (about 2~10mA).

1) To meet the minimum load current (>10mA) requirement, R_1 is recommended to be 125ohm or lower. As TX1117-ADJ can keep itself stable at load current about 2mA, R_1 is not allowed to be higher than 625ohm.

2) Using a bypass capacitor (C_{ADJ}) between the ADJ pin and ground can improve ripple rejection. This bypass capacitor prevents ripple from being amplified as the output voltage is increased. The impedance of C_{ADJ} should be less than R_1 to prevent ripple from being amplified. As R_1 is normally in the range of 100Ω~500Ω, the value of C_{ADJ} should satisfy this equation: $1/(2\pi \times f_{ripple} \times C_{ADJ}) < R_1$.

Thermal Considerations

We have to take heat dissipation into great consideration when output current or differential voltage of input and output voltage is large. Because in such cases, the power dissipation consumed by TX1117 is very large. TX1117 series uses SOT-223 package type and its thermal resistance is about 20°C/W. And the copper area of application board can affect the total thermal resistance. If copper area is 5cm*5cm (two sides), the resistance is about 30°C/W. So the total thermal resistance is about 20°C/W + 30°C/W. We can decrease total thermal resistance by increasing copper area in application board. When there is no good heat dissipation copper are in PCB, the total thermal resistance will be as high as 120°C/W, then the power dissipation of TX1117 could allow on itself is less than 1W. And furthermore, TX1117 will work at junction temperature higher than 125°C under such condition and no lifetime is guaranteed.



Typical Performance Characteristics

T_A=25°C, unless otherwise noted

Output Voltage vs. Input Voltage (V_{OUT}=3.3V)

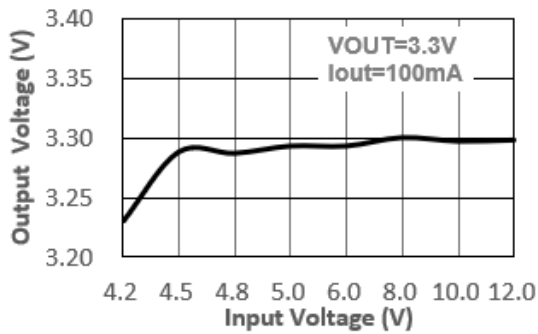

Output Voltage vs. Input Voltage (V_{OUT}=1.8V)

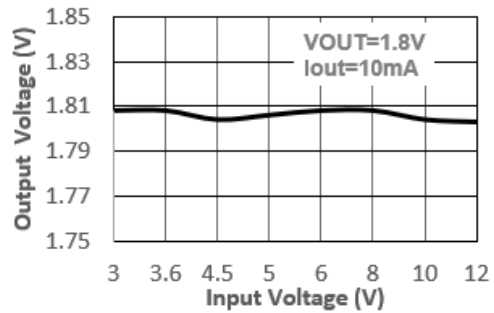

Output Voltage vs. Output Current (V_{OUT}=3.3V)

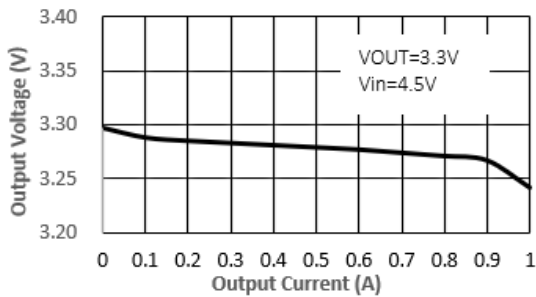

Output Voltage vs. Output Current (V_{OUT}=1.8V)

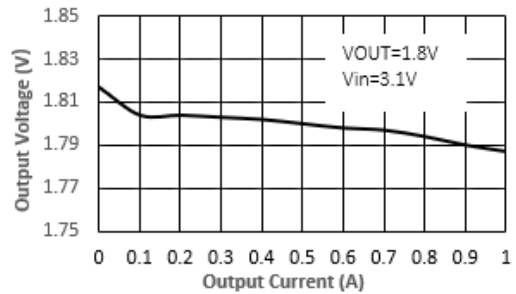

Line Regulation vs. Junction Temperature

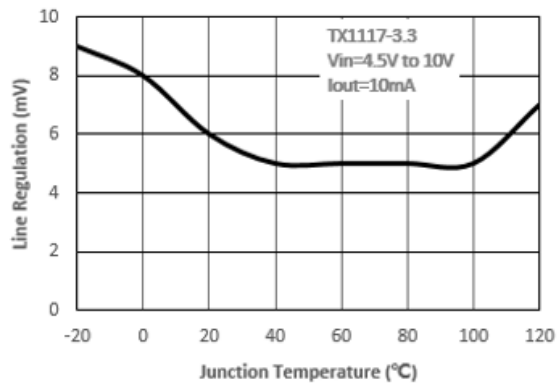

Load Regulation vs. Junction Temperature

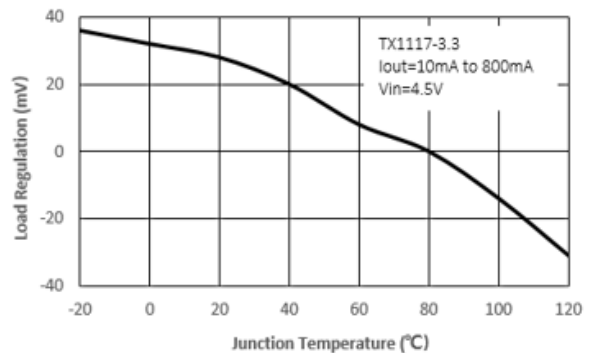



<http://www.txsemi.com>

TX1117 1A Bipolar Linear Regulator

Reference Voltage vs. Junction Temperature

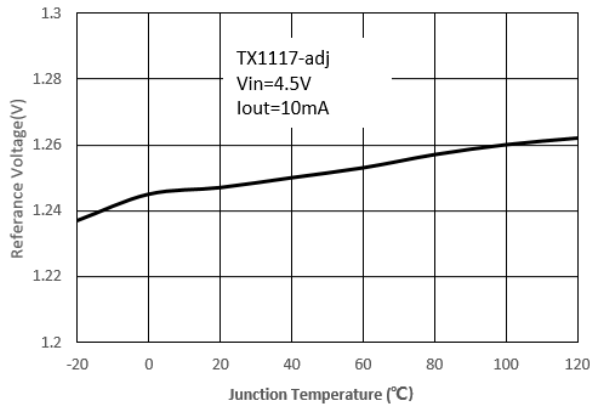

Output Voltage vs. Junction Temperature

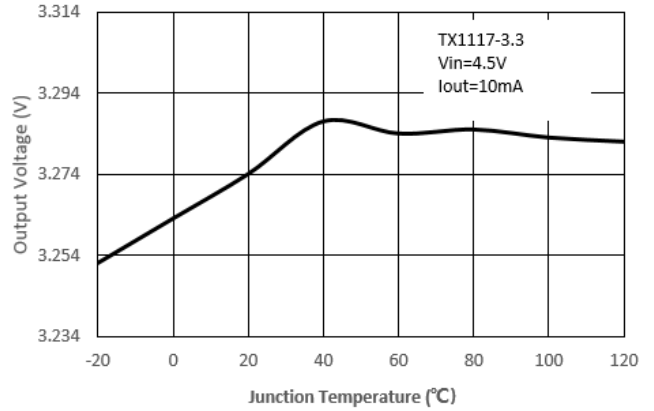

Minimum Load Current vs. Junction Temperature

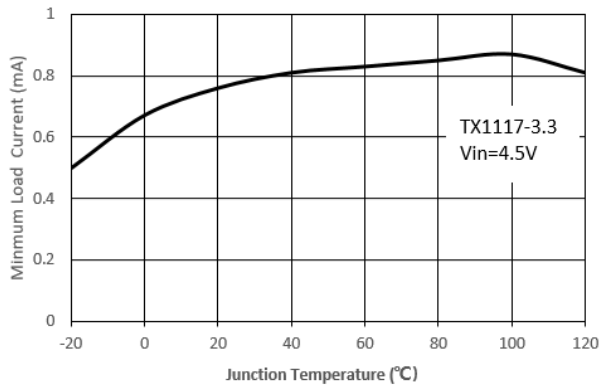

Adjust Pin Current vs. Junction Temperature

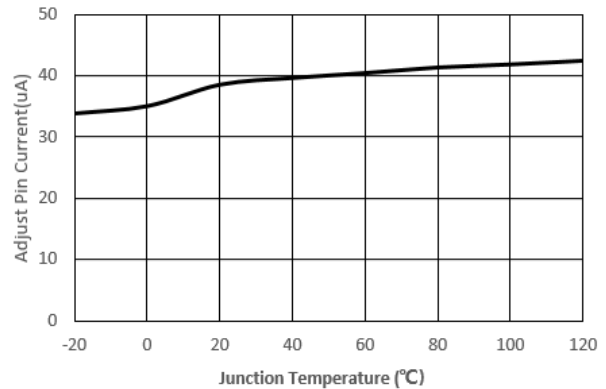

PSRR vs. Frequency

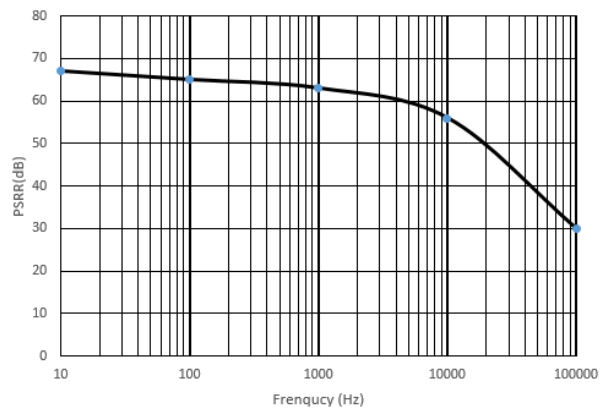

Dropout Voltage vs. Output Current

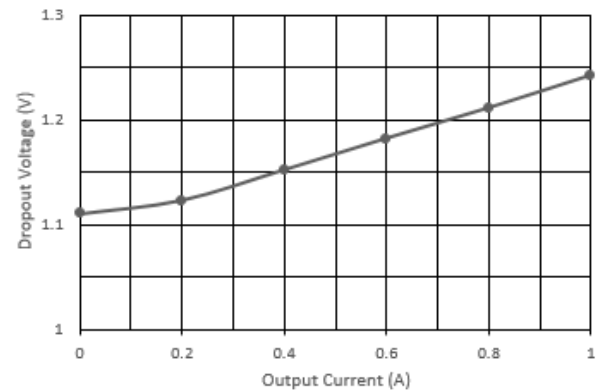



<http://www.txsemi.com>

TX1117 1A Bipolar Linear Regulator

Line Transient Response

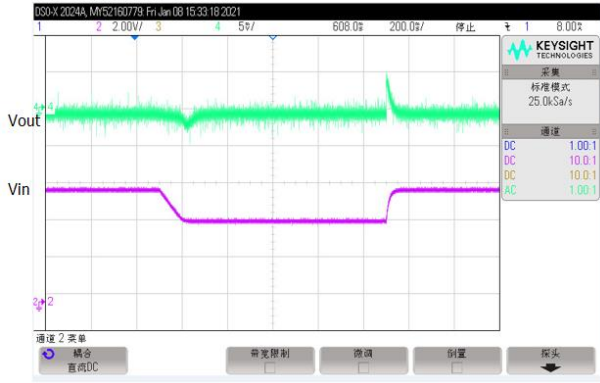

Load Transient Response

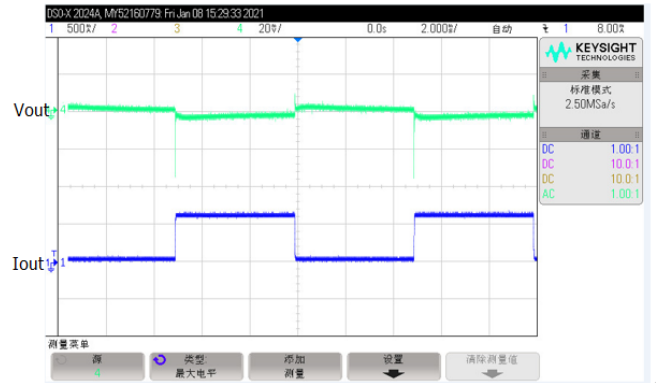

Marking Information

Marking	Designator	Description
(TX)1117 XX SYWW	(TX)1117	Product code
	XX	Output Voltage(1.2~12.0V)
	S	Order NO
	YWW	DATE CODE

Note: "XX" stands for output voltages. Other voltages can be specially customized



Package Information

SOT-223 PACKAGE OUTLINE DIMENSIONS

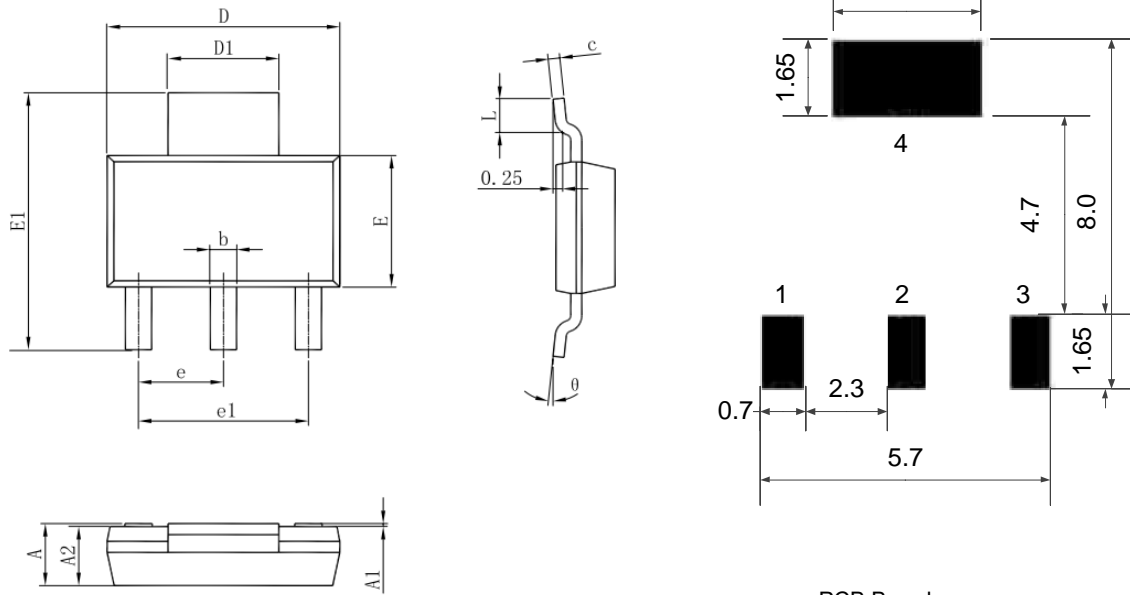

PCB Board

Symbol	Dimensions In Millimeters		Dimensions In Inches	
	Min	Max	Min	Max
A	1.520	1.800	0.060	0.071
A1	0.000	0.100	0.000	0.004
A2	1.500	1.700	0.059	0.067
b	0.660	0.820	0.026	0.032
c	0.250	0.350	0.010	0.014
D	6.400	6.600	0.252	0.260
D1	2.900	3.100	0.114	0.122
E	3.300	3.700	0.130	0.146
E1	6.830	7.070	0.269	0.278
e	2.300(BSC)		0.091(BSC)	
e1	4.500	4.700	0.177	0.185
L	0.900	1.150	0.035	0.045
theta	0°	10°	0°	10°



<http://www.txsemi.com>

TX1117 1A Bipolar Linear Regulator

TO-252-2L PACKAGE OUTLINE DIMENSIONS

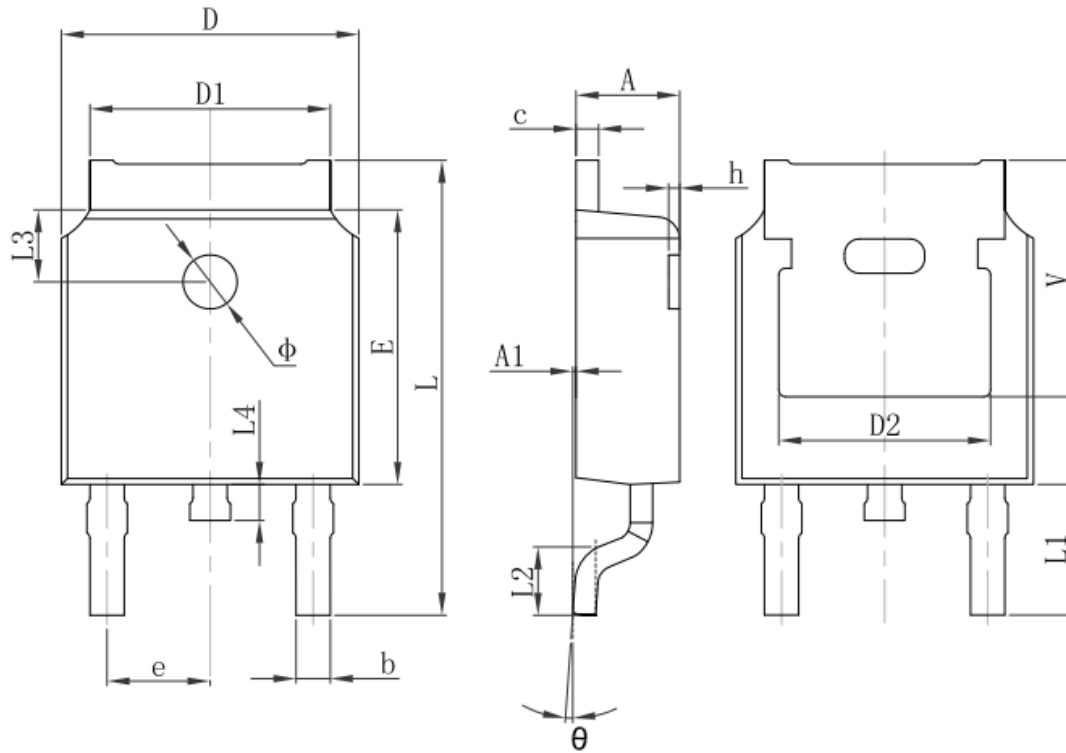

Symbol	Dimensions In Millimeters		Dimensions In Inches	
	Min.	Max.	Min.	Max.
A	2.200	2.400	0.087	0.094
A1	0.000	0.127	0.000	0.005
b	0.660	0.860	0.026	0.034
c	0.460	0.580	0.018	0.023
D	6.500	6.700	0.256	0.264
D1	5.100	5.460	0.201	0.215
D2	4.830 REF.		0.190 REF.	
E	6.000	6.200	0.236	0.244
e	2.186	2.386	0.086	0.094
L	9.800	10.400	0.386	0.409
L1	2.900 REF.		0.114 REF.	
L2	1.400	1.700	0.055	0.067
L3	1.600 REF.		0.063 REF.	
L4	0.600	1.000	0.024	0.039
φ	1.100	1.300	0.043	0.051
θ	0°	8°	0°	8°
h	0.000	0.300	0.000	0.012
V	5.350 REF.		0.211 REF.	



3-pin SOT89 Outline Dimensions

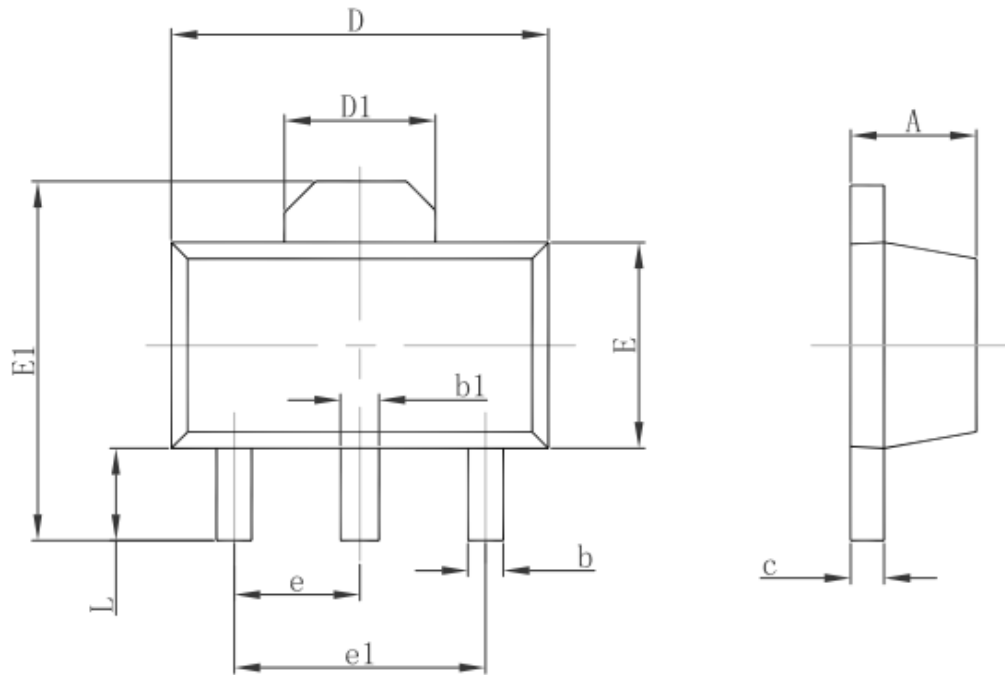

Symbol	Dimensions In Millimeters		Dimensions In Inches	
	Min.	Max.	Min.	Max.
A	1.400	1.600	0.055	0.063
b	0.320	0.520	0.013	0.020
b1	0.400	0.580	0.016	0.023
c	0.350	0.440	0.014	0.017
D	4.400	4.600	0.173	0.181
D1	1.550 REF.		0.061 REF.	
E	2.300	2.600	0.091	0.102
E1	3.940	4.250	0.155	0.167
e	1.500 TYP.		0.060 TYP.	
e1	3.000 TYP.		0.118 TYP.	
L	0.900	1.200	0.035	0.047



<http://www.txsemi.com>

TX1117

1A Bipolar Linear Regulator

© **Shanghai TX Semiconductor Sci.-Tech. Co., Ltd.**

TX cannot assume responsibility for use of any circuitry other than circuitry entirely embodied in a TX product. No circuit patent license, copyrights or other intellectual property rights are implied. TX reserves the right to make changes to their products or specifications without notice. Customers are advised to obtain the latest version of relevant information to verify, before placing orders, that information being relied on is current and complete.