

TX6213 series

300mA Low Power LDO

<http://www.txsemi.com>

Features

- Input voltage: 2.5V~6.5V
- Output range: 1.0V~3.6V
(customized by every 0.1V step)
- Maximum output current: 300mA @
VIN-VOUT=0.5V
- PSRR: 75dB @1KHz
- Dropout voltage: 220mV @ IOU=200mA
- Quiescent current: 50µA Typ.
- Shut-down current: <1µA
- Recommend capacitor: 1µF
- Ultra Low Output Noise: 20µVRMS

Applications

- MP3/MP4 Players
- Cellphones, radiophone, digital cameras
- Bluetooth, wireless handsets
- Others portable electronics device

General Description

The TX6213 is a high accuracy, low noise, high speed, low dropout CMOS Linear regulator with high ripple rejection and fast discharge function. The devices offer a new level of cost effective performance in cellular phones, laptop and notebook computers, and other portable devices.

TX6213 can provide product selections of output value in the range of 1.0V~3.6V by every 0.1V step.

The current limiter's fold-back circuit also operates as a short circuit protection and an output current limiter at the output pin.

The TX6213 regulators are available in standard SOT23-5L and DFN1×1-4 packages. Standard products are Pb-free and Halogen-free.

Selection Table

Part No.	Package	Temperature	Tape & Reel
TX6213-XXM5G	SOT23-5L	-40 ~ +85°C	3000/REEL
TX6213-XXFCG	DFN1×1-4	-40 ~ +85°C	10000/REEL

Note: XX indicates 1.0V~3.3V by 0.1V step. For example, 28 means product outputs 2.8V

Order Information

TX6213-①②

Designator	Description
①	Voltage version: XX: 1.0V~3.6V by 0.1V step Example: 28: 2.8V
②	Package: M5G: SOT23-5L FCG: DFN1×1-4

Block Diagram

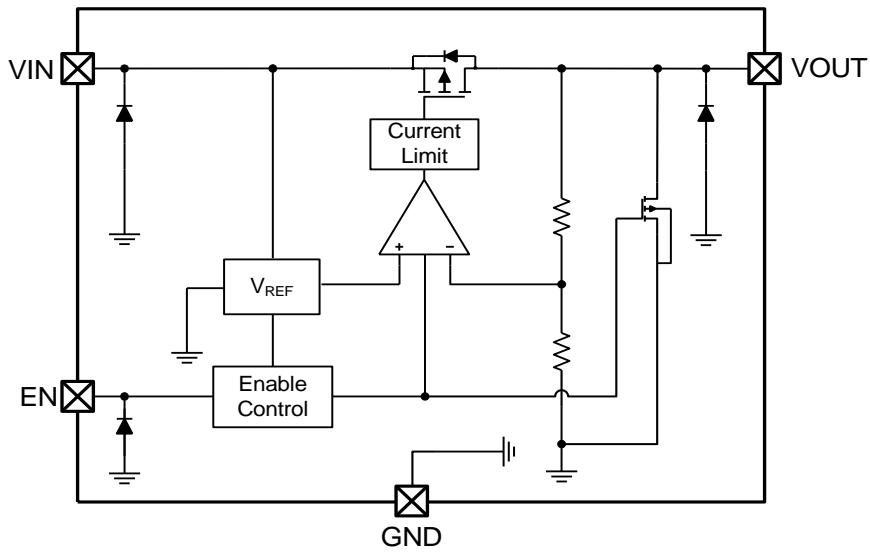

Pin Assignment

SOT23-5 (Top View)

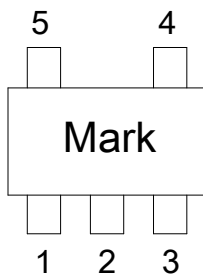

PIN NO	SYMBOL	I/O	DESCRIPTION
SOT23-5L			
1	VIN	Power	Input
2	GND	Ground	Ground
3	EN	I	Enable(Active high, not floating)
4	NC	/	Not connected
5	VOUT	O	Output

DFN1x1-4L (Top View)

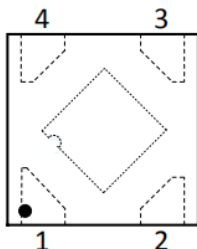

PIN NO	SYMBOL	I/O	DESCRIPTION
DFN1x1-4			
1	VOUT	O	Output
2	GND	Ground	Ground
3	CE	I	Enable(Active high, not floating)
4	VIN	Power	Input

TX6213 series

300mA Low Power LDO

<http://www.txsemi.com>

Absolute Maximum Ratings

Input Voltage.....	-0.3V to 8V	Storage Temperature	-55°C to 150°C
Output Current.....	300mA	Package Lead Soldering Temperature.....	260°C
Operating Temperature	-40°C to 85°C	Junction Temperature.....	-40°C to 125°C
Ambient Temperature.....	-40°C to 85°C		

Note: These are stress ratings only. Stresses exceeding the range specified under "Absolute Maximum Ratings" may cause substantial damage to the device. Functional operation of this device at other conditions beyond those listed in the specification is not implied and prolonged exposure to extreme conditions may affect device reliability.

Thermal Information

Symbol	Parameter	Package	Max.	Unit
θ_{JA}	Thermal Resistance (Junction to Ambient) (Assume no ambient airflow, no heat sink)	SOT23-5	500	°C/W
		DFN1x1—4	250	
P_D	Power Dissipation	SOT23-5	0.30	W
		DFN1x1—4	0.60	

Note: P_D is measured at $T_a = 25^\circ\text{C}$

Electrical Characteristics

The following specifications apply for $V_{OUT}=2.8\text{V}, T_A=25^\circ\text{C}$, unless specified otherwise

SYMBOL	ITEMS	CONDITIONS	MIN	TYP	MAX	UNIT
V_{IN}	Input Voltage				6.5	V
V_{OUT}	Output Range	$V_{OUT} < 2\text{V}, V_{IN}=2.7\text{V}, I_{OUT}=1\text{mA}$	-3	V_{OUT}	3	%
		$V_{OUT} \geq 2\text{V}, I_{OUT}=1\text{mA}$	-2	V_{OUT}	2	
I_Q	Quiescent Current	$V_{OUT}=2.8\text{V}, I_{OUT}=0$		50		μA
I_{LIMIT}	Current Limit	$V_{IN}=V_{EN}=4.5\text{V}$		300		mA
V_{DROP}	Dropout Voltage	$V_{OUT}=2.8\text{V}, I_{OUT}=200\text{mA}$		220	250	mV
		$V_{OUT}=2.8\text{V}, I_{OUT}=300\text{mA}$		320	350	
ΔV_{LINE}	Line Regulation	$V_{IN}=2.7\sim 5.5\text{V}, I_{OUT}=1\text{mA}$		0.01	0.15	%/V
ΔV_{LOAD}	Load Regulation	$V_{OUT}=2.8\text{V}, I_{OUT}=1\sim 300\text{mA}$		40	70	mV
I_{SHORT}	Short Current	$V_{EN}=V_{IN}, V_{OUT}$ Short to GND with 1Ω		80		mA
I_{SHDN}	Shut-down Current	$V_{EN}=0\text{V}$			1	μA
PSRR	Power Supply Rejection Rate	$V_{IN}=5V_{DC}+0.5V_{P-P}$ $F=1\text{KHz}, I_{OUT}=10\text{mA}$		75		dB
		$V_{IN}=5V_{DC}+0.5V_{P-P}$ $F=1\text{MHz}, I_{OUT}=10\text{mA}$		55		
V_{ENH}	EN logic high voltage	$V_{IN}=5.5\text{V}, I_{OUT}=1\text{mA}$	1.2		V_{IN}	V
V_{ENL}	EN logic low voltage	$V_{IN}=5.5\text{V}, V_{OUT}=0\text{V}$			0.4	V
I_{EN}	EN Input Current	$V_{EN}=0$ to 5.5V			1	μA
e_{NO}	Output Noise Voltage	10Hz to 100KHz, $C_{OUT}=1\mu\text{F}$		20		μV_{RMS}

TX6213 series 300mA Low Power LDO

<http://www.txsemi.com>

Marking Description

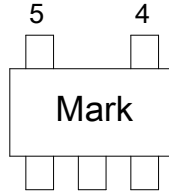

MARKING	
VOLTAGE(V)	Package
	SOT23-5、SOT23-3、SOT23
1.2	LVBX
1.5	LVEX
1.8	LVKX
2.5	LVTX
2.8	LVXX
3.0	LVZX
3.3	LV2X

① Represents product series

Mark	Product Series
L	TX6213

② Represents type of regulator

Vout:0.1~3.3V	Vout:3.4~6.0V
V	A

③ Represents output Voltage

Mark	Output Voltage(V)		Mark	Output Voltage(V)	
0	-	3.1	F	1.6	4.6
1	-	3.2	H	1.7	4.7
2	-	3.3	K	1.8	4.8
3	-	3.4	L	1.9	4.9
4	-	3.5	M	2.0	5.0
5	-	3.6	N	2.1	-
6	-	3.7	P	2.2	-
7	-	3.8	R	2.3	-
8	0.9	3.9	S	2.4	-
9	1.0	4.0	T	2.5	-
A	1.1	4.1	U	2.6	-
B	1.2	4.2	V	2.7	-
C	1.3	4.3	X	2.8	-
D	1.4	4.4	Y	2.9	-
E	1.5	4.5	Z	3.0	-

④ Resresents production lot number

TX6213 series

300mA Low Power LDO

<http://www.txsemi.com>

0 to 9, A to Z reverse character of 0 to 9, A to Z repeated (G, I, O, Q, W excepted)

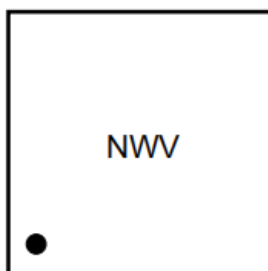

DFN1x1-4L

“N” : Product code, here use “L” stand for “TX6213” .

“W” : The week of manufacturing. “A” stands for week 1, “Z” stands for week 26, “a” stands for week 27, “z” stands for week 52.

“V” : Output voltage code.

Output voltage (V)	code
1.0	A
1.2	B
1.5	C
1.8	D
2.5	E
2.6	F
2.8	M
3.0	G
3.3	H
3.6	I

TX6213 series

300mA Low Power LDO

<http://www.txsemi.com>

Typical Performance Characteristics

$C_{IN}=1\mu F$, $C_{OUT}=1\mu F$, $V_{IN}=4.5V$, $V_{OUT}=2.8V$, $T_A=25^\circ C$, unless specified otherwise.

(Package:SOT23-5L)

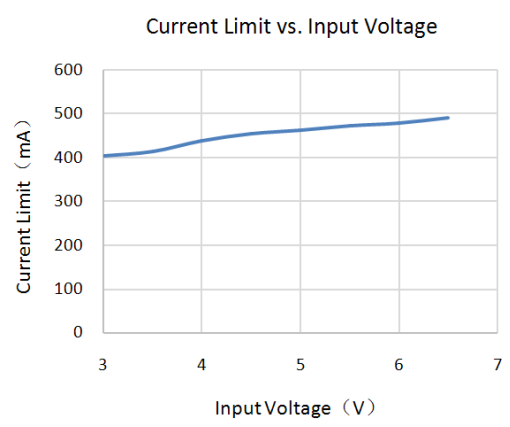
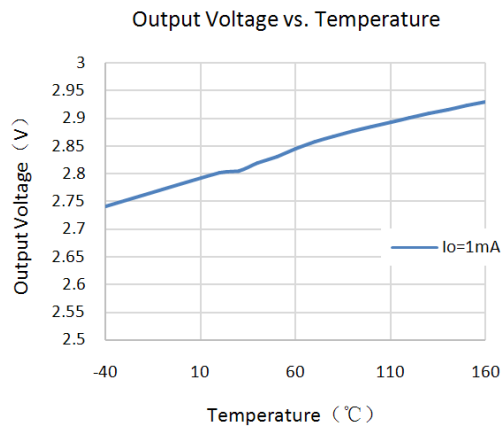
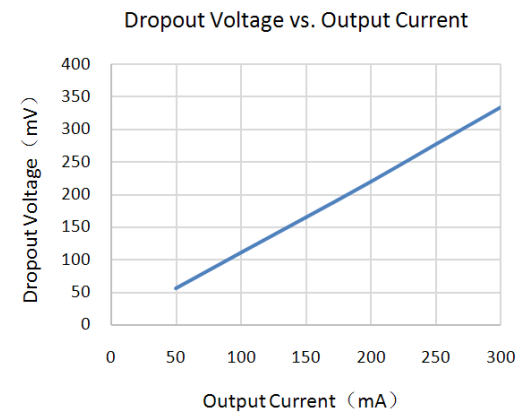
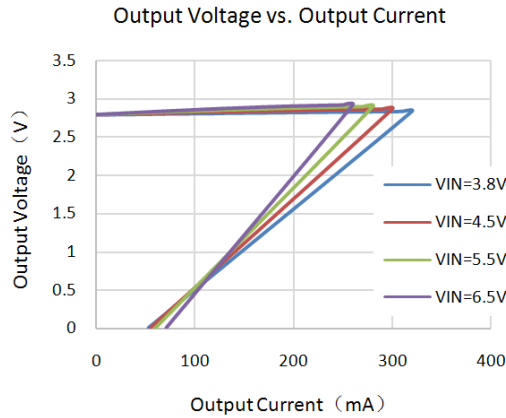
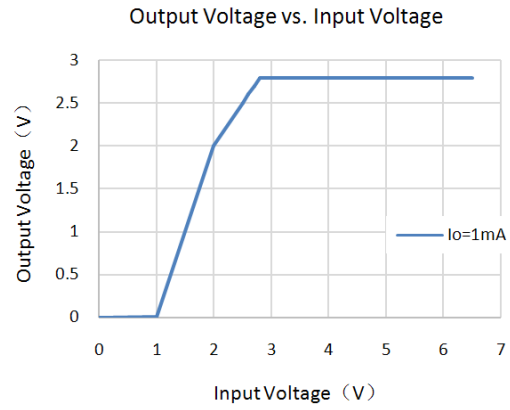
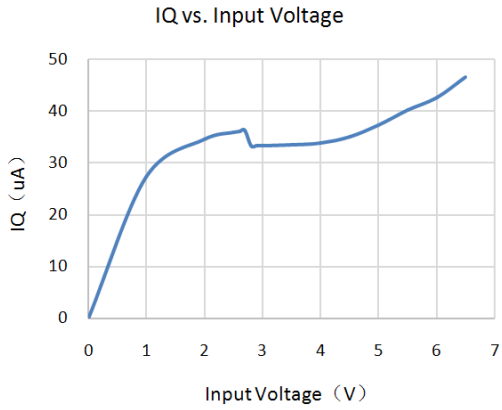

TX6213 series 300mA Low Power LDO

<http://www.txsemi.com>

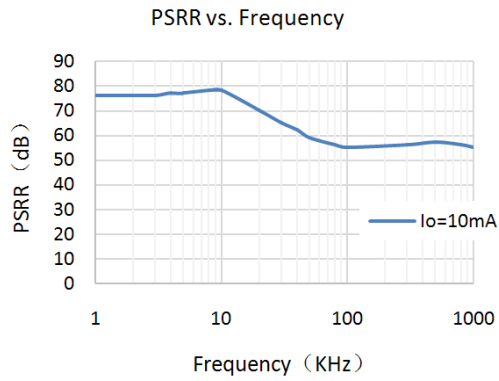

EN ON / OFF

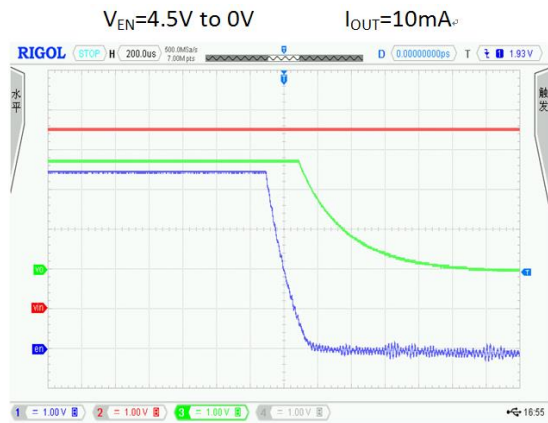
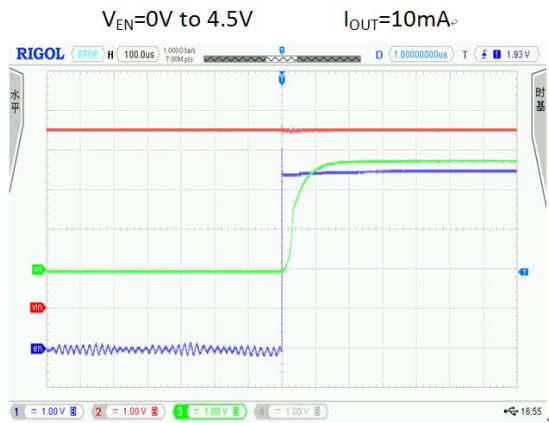

Power ON / OFF

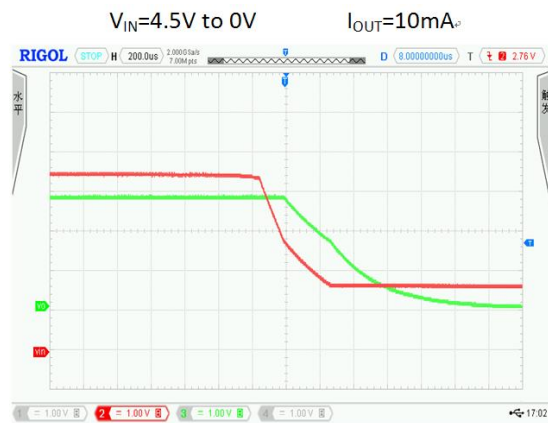
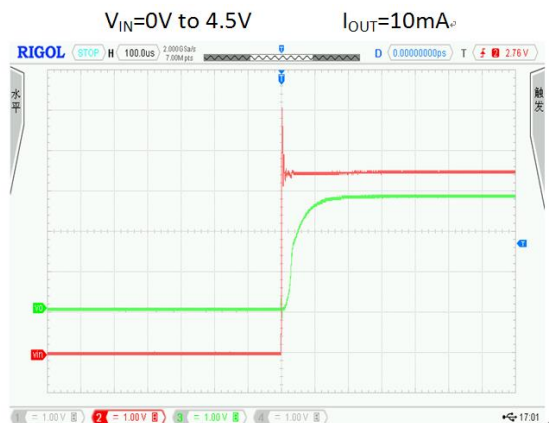

TX6213 series 300mA Low Power LDO

<http://www.txsemi.com>

Line Transient

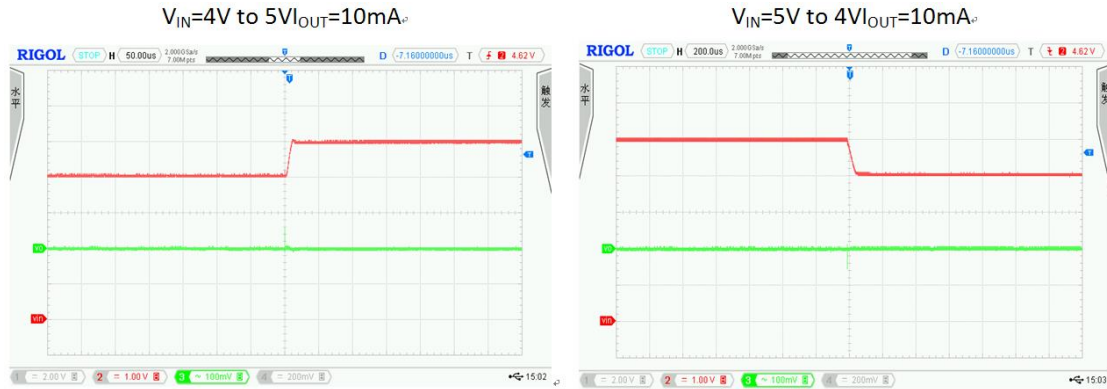

Load Transient

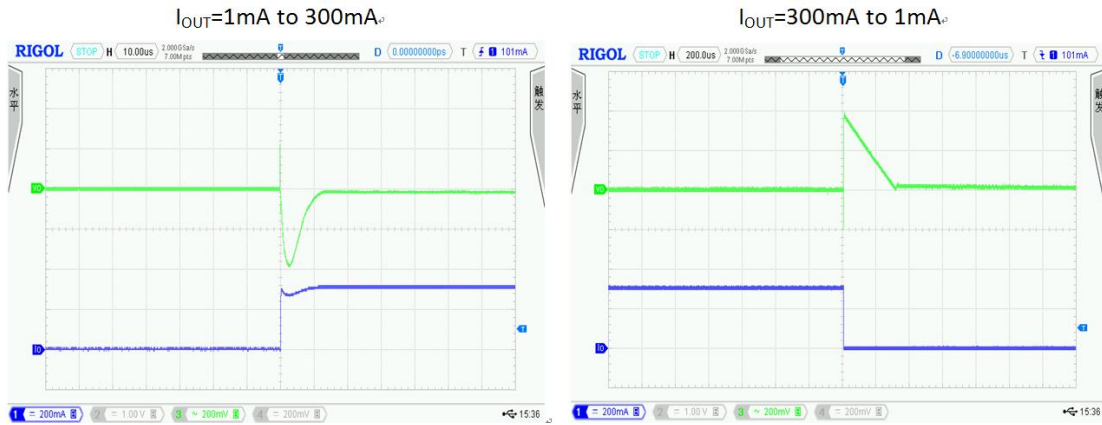

Application Circuits

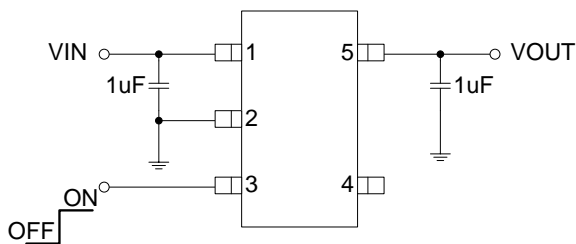

TX6213 series

300mA Low Power LDO

<http://www.txsemi.com>

Application Information

INPUT CAPACITOR

An input capacitor of $\geq 1.0\mu\text{F}$ is required between the VIN and GND pin. This capacitor must be located within 1cm distance from VIN pin and connected to a clear ground. A ceramic capacitor is recommended although a good quality tantalum or film may be used at the input. However, a tantalum capacitor can suffer catastrophic failures due to surge current when connected to a low impedance power supply (such as a battery or a very large capacitor).

There is no requirement for the ESR on the input capacitor, but the tolerance and temperature coefficient must be considered in order to ensure the capacitor work within the operation range over the full range of temperature and operating conditions.

OUTPUT CAPACITOR

In applications, it is important to select the output capacitor to keep in stable operation. The output capacitor must meet all the requirements specified in the following recommended capacitor table over all conditions in applications. The minimum capacitance for stability and correct operation is $0.6\mu\text{F}$. The capacitance tolerance should be $\pm 30\%$ or better over the operation temperature range. The recommended capacitor type is X7R to meet the full device temperature specification.

The capacitor application conditions also include DC-bias, frequency and temperature. Unstable operation will result if the capacitance

drops below minimum specified value (see the next section Capacitor Characteristics).

The TX6213 is designed to work with very small ceramic output capacitors. A $1.0\mu\text{F}$ capacitor (X7R type) with ESR type between 0 and $400\text{m}\Omega$ is suitable in the applications. X5R capacitors may be used but have a narrow temperature range. With these and other capacitor types (Y5V, Z6U) that may be used, selection relies on the range of operating conditions and temperature range for a specified application. It may also be possible to use tantalum or film capacitors at the output, but these are not as good for reasons of size and cost. It is also recommended that the output capacitor be located within 1cm from the output pin and return to a clean ground wire.

NO-LOAD STABILITY

The TX6213 will remain stable and in regulation with no external load. This is especially important in CMOSRAM keep-alive applications.

ON/OFF INPUT OPERATION

The TX6213 is turned off by pulling the EN pin low, and turned on by pulling it high. If this function is not used, the VEN pin should be tied to VIN to keep the regulator output on at all time. To assure proper operation, the signal source used to drive the VEN input must be able to swing above and below the specified turn-on/off voltage thresholds listed in the Electrical Characteristics section under VIL and VIH.

TX6213 series 300mA Low Power LDO

<http://www.txsemi.com>

Package Information SOT23-5 Outline Dimensions

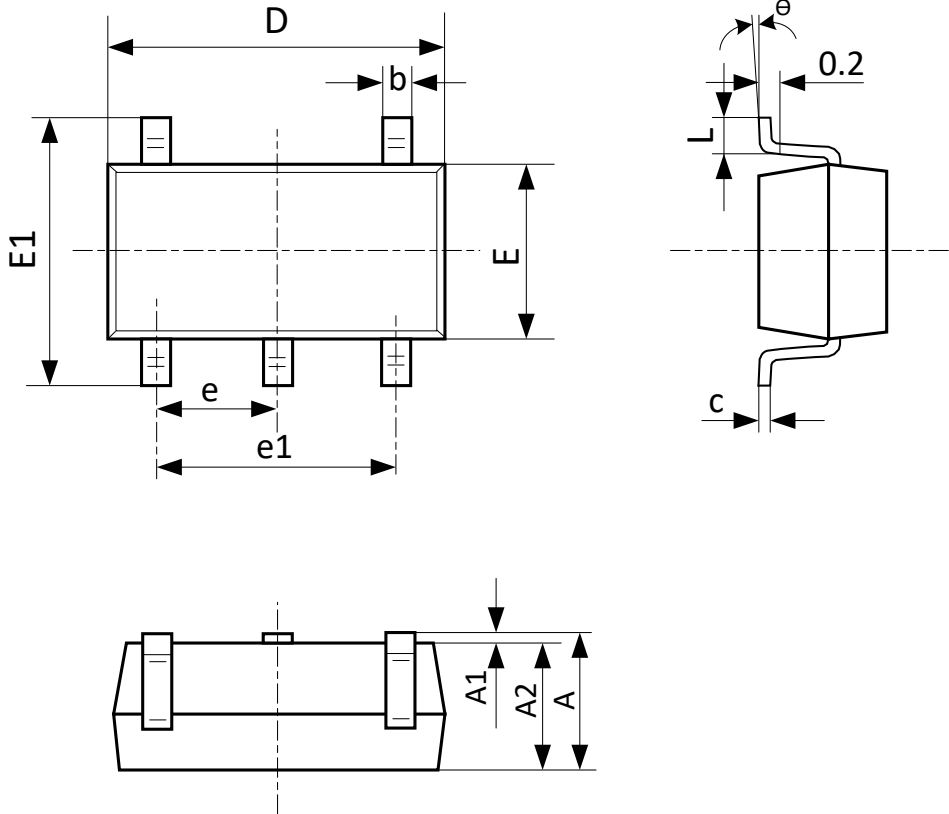

Symbol	Dimensions In Millimeters		Dimensions In Inches	
	Min	Max	Min	Max
A	1.050	1.250	0.041	0.049
A1	0.000	0.100	0.000	0.004
A2	1.050	1.150	0.041	0.045
b	0.300	0.500	0.012	0.020
c	0.100	0.200	0.004	0.008
D	2.820	3.020	0.111	0.119
E	1.500	1.700	0.059	0.067
E1	2.650	2.950	0.104	0.116
e	0.950(BSC)		0.037(BSC)	
e1	1.800	2.000	0.071	0.079
L	0.300	0.600	0.012	0.024
θ	0°C	8°C	0°C	8°C

DFN1x1-4 Outline Dimensions

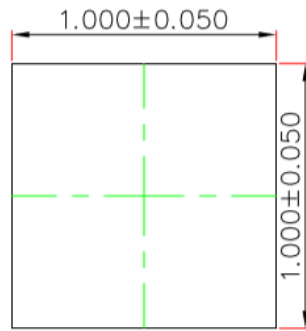

TOP VIEW
[顶视图]

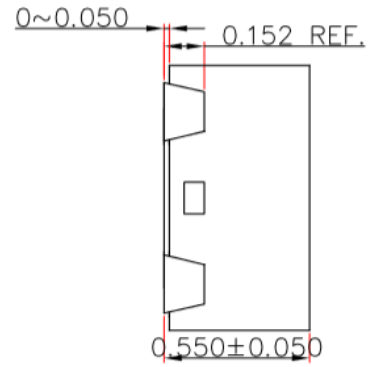

SIDE VIEW
侧视图

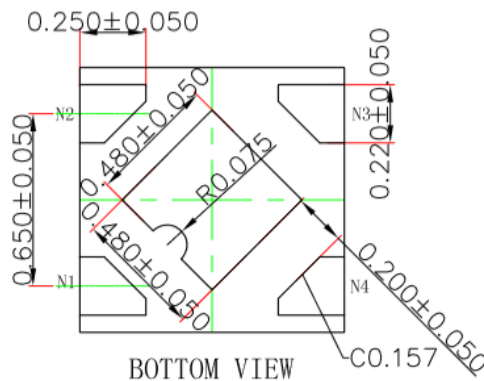

BOTTOM VIEW
背视图

TX6213 series

300mA Low Power LDO

<http://www.txsemi.com>

© Shanghai TX Electronics Sci-Tech Co., Ltd

TX cannot assume responsibility for use of any circuitry other than circuitry entirely embodied in a TX product. No circuit patent license, copyrights or other intellectual property rights are implied. TX reserves the right to make changes to their products or specifications without notice. Customers are advised to obtain the latest version of relevant information to verify, before placing orders, that information being relied on is current and complete.