



TX6051

600mA High Speed Low Noise LDO

Features

- Dropout Voltage: 100mV @ 100mA (3.0V type)
- High Ripple Rejection: 70dB@1KHz
- Internal protector: current limiter, short protector and over temperature protection
- FB voltage: A. 0.6V
B. 0.75V
C. 0.8V
- Low Power Consumption: 50uA (TYP.)
- Minimum Output Current : 600mA (VIN ≧ VOUT+1V)
- Standby Current: less than 0.1μA
- Instructions with Power Good
- No fast discharge function
- SOT23-5, UTDFN1.2x1.2-6L Package

Applications

- Cellular Handsets
- Battery-Powered Equipment
- Wi-Fi Router Portable AV equipment
- Hand-Held Instruments
- Portable Information Application
- Adjustable power supply

General Description

The TX6051 series are highly precise, low noise, positive voltage LDO regulators manufactured using CMOS processes. The series achieves high ripple rejection and low dropout and consists of a standard voltage source, an error correction, current limiter and a phase compensation circuit plus a driver transistor. External output feedback,

customers can easily get the required voltage. In order to make the load current does not exceed the current capacity of the output transistor, built-in over-current protection, over temperature protection and short circuit protection. The internal op amp with advanced structure, the output capacitor can be omitted.

Order Information

TX6051①-adj②③

Designator	Symbol	Description
①	A	0.6V
	B	0.75V
	C	0.8V
②	M5	Package: SOT23-5
	UD	Package: UTDFN1.2x1.2-6L
③	R	RoHS / Pb Free
	G	Halogen Free



TX6051

<http://www.txsemi.com>

600mA High Speed Low Noise LDO

Pin Configuration

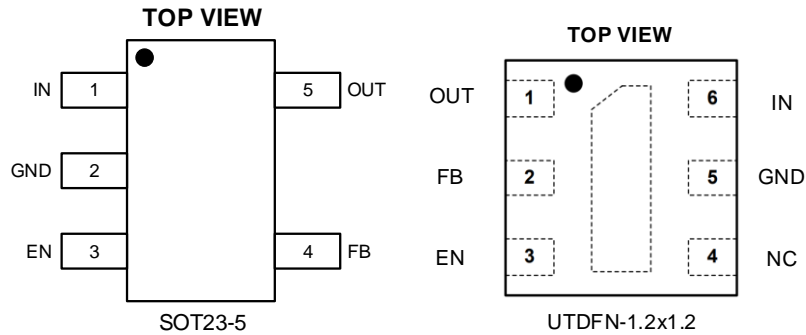

Pin Assignment

Pin No.		Pin Name	Function
SOT23-5	UTDFN1.2x1.2		
1	6	IN	Input voltage pin for the regulator
2	5	GND	Ground
3	3	EN	Enable Control
4	2	FB	FB pin for adjustable output option
5	1	OUT	Output voltage pin for the regulator
---	4	NC	Not Connected

Function Block Diagram

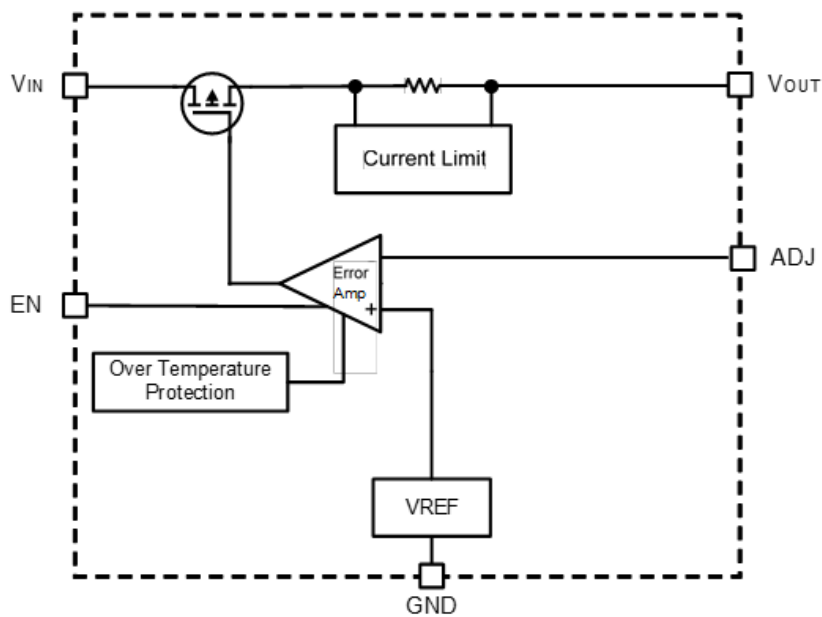



Absolute Maximum Ratings

Item	Min	Max	Unit
V _{IN} voltage	2	V _{SS} +6.5	V
V _{EN} voltage	V _{SS} -0.3	V _{IN} +0.3	V
V _{FB} voltage	V _{SS} -0.3	V _{IN} +0.3	V
V _{OUT} voltage	V _{SS} -0.3	V _{IN} +0.3	
Power dissipation	500		mW
Operating Ambient Temperature	-40	85	°C
Maximum junction temperature		125	°C
Storage temperature, T _{stg}	-40	125	°C

Note (1): Exceeding these ratings may damage the device.

Note (2): The device is not guaranteed to function outside of its operating conditions.

Caution: The absolute maximum ratings are rated values exceeding which the product could suffer physical damage. These values must therefore not be exceeded under any conditions.

Thermal Information

Item	Description	Value	Unit
R _{θJA}	Junction-to-ambient thermal resistance ⁽¹⁾⁽²⁾	120	°C/W
R _{θJC(top)}	Junction-to-case (top) thermal resistance	90	°C/W

Note (1): The package thermal impedance is calculated in accordance to JESD 51-7.

Note (2): Thermal Resistances were simulated on a 4-layer, JEDEC board

Typical Application Circuit

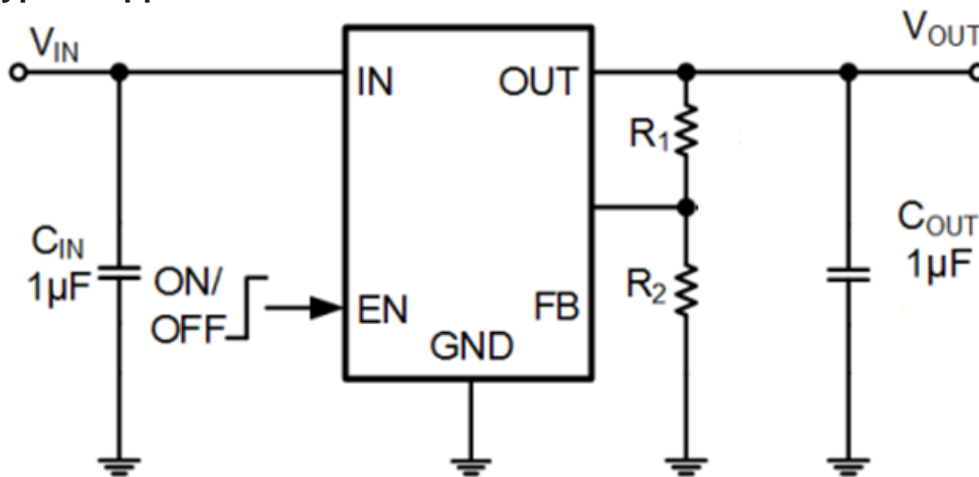

Figure1: Typical Application Circuit With FB

Note1: $V_{OUT} = V_{FB} \times (1 + R1/R2)$



TX6051

<http://www.txsemi.com>

600mA High Speed Low Noise LDO

Electrical Characteristics

$V_{IN} = V_{OUT} + 1V$, $T_A = 25^\circ C$, unless otherwise noted.

Parameter	Symbol	Test Conditions	Min	Typ.	Max	Units
Feedback Voltage	A-V _{FB}	$V_{IN}=4.2V$, $V_{OUT}=3.3V$, $I_{OUT}=30mA$	580	600	620	mV
	B-V _{FB}		730	750	770	mV
	C-V _{FB}		780	800	820	mV
Output Current	I_{OUT}	$V_{IN}=4.2V@V_{OUT}=3.3V$		600		mA
Dropout Voltage	V_{drop}	$I_{OUT}=50 mA$	-	0.08	0.11	V
		$I_{OUT}=100 mA$	-	0.10	0.15	
Line Regulations	$\frac{\Delta V_{OUT}}{\Delta V_{IN} \times V_{OUT}}$	$V_{OUT(S)}+0.5 V \leq V_{IN} \leq 7V$ $I_{OUT}=30mA$	-	0.10	0.20	%/V
Load Regulation	ΔV_{OUT2}	$V_{IN}=V_{OUT(S)}+1.0 V$ $1.0mA \leq I_{OUT} \leq 100mA$	-	50	100	mV
Output Voltage Temperature Characteristics	$\frac{\Delta V_{OUT}}{T_a \times V_{OUT}}$	$V_{IN}=V_{OUT(S)}+1.0V$, $I_{OUT}=10mA$ $-40^\circ C \leq T_A \leq 85^\circ C$	-	± 100	-	ppm/ $^\circ C$
Supply Current	I_{SS1}	$V_{IN}=V_{OUT(S)}+1.0 V$	-	50	-	μA
Shutdown Current	I_{shut}	$V_{IN}=5V$, $V_{EN}=0$	-	-	0.1	μA
Input Voltage	V_{IN}	-	-	-	6	V
Ripple-Rejection	PSRR	$V_{IN}=V_{OUT(S)}+1.0V$, $f=1kHz$, $V_{RIP}=0.5V_{rms}$, $I_{OUT}=50 mA$	-	70	-	dB
Short-circuit Current	I_{short}	$V_{IN}=V_{OUT(S)}+1.0V$, ON/OFF Terminal is ON, $V_{OUT}=0V$	-	200	-	mA
EN "High Voltage"	V_{ENH}		1.2			V
EN "Low" Voltage	V_{ENL}				0.4	V
EN "High Current"	I_{ENH}	$V_{IN}=V_{EN}=V_{OUT(T)}+1V$	-0.1		0.1	μA
EN "Low" Current	I_{ENL}	$V_{IN}=V_{OUT(T)}+1V$, $V_{EN}=V_{SS}$	-0.1		0.1	μA



TX6051

<http://www.txsemi.com>

600mA High Speed Low Noise LDO

Typical Performance Characteristics

Note: $C_{IN}=1\mu F$ $C_{OUT}=1\mu F$ $V_{OUT}=3.3V$ $T=25^\circ C$ unless specified otherwise

(1) Quiescent Current VS Input Voltage

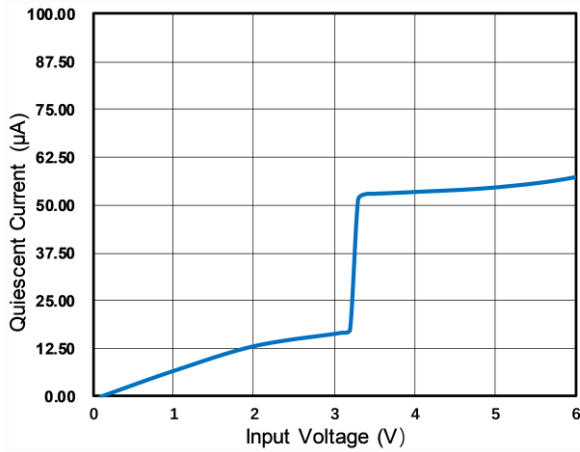

(2) Output Voltage VS Input Voltage

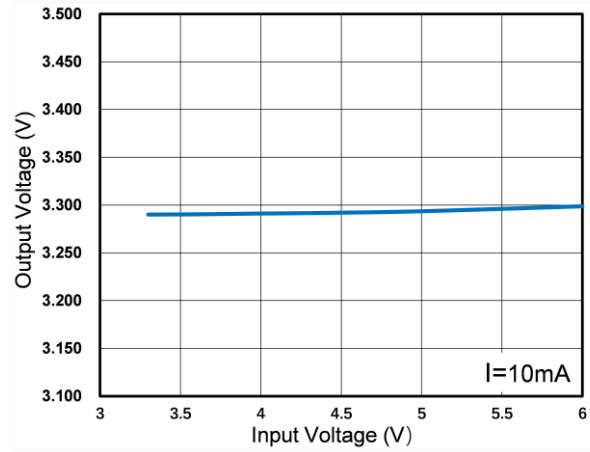

(3) Output Voltage VS Output Current

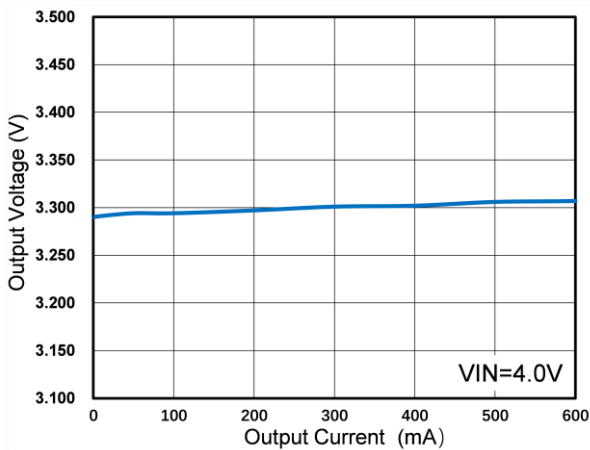

(4) Short-Circuit Current VS Input Voltage

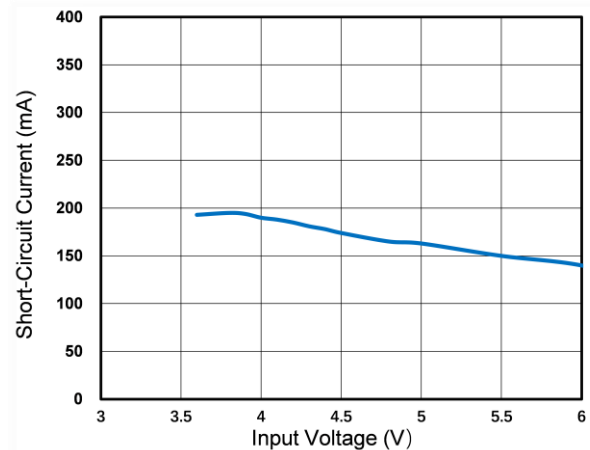

(5) Dropout Voltage VS Output Current

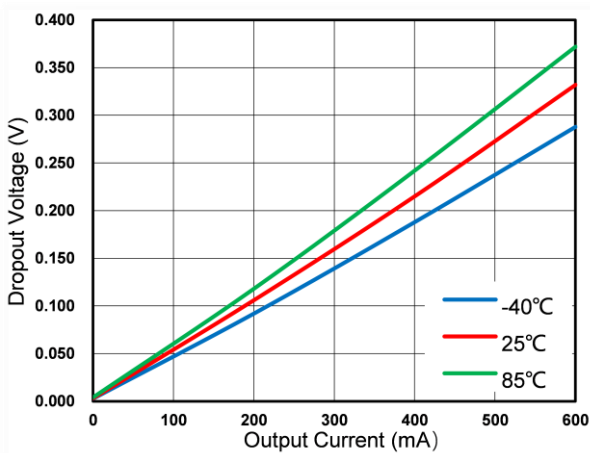

(6) Dropout Voltage VS Temperature

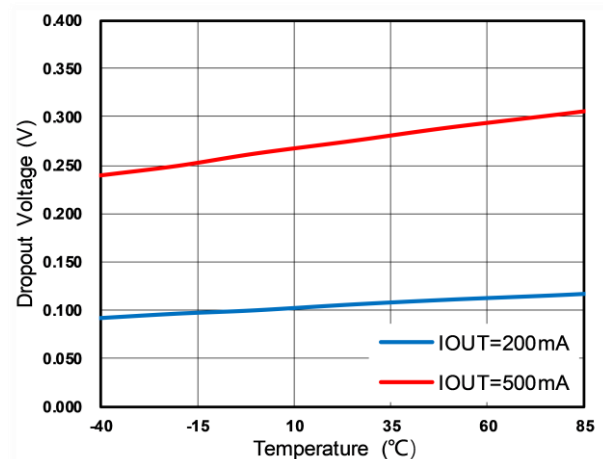



TX6051

<http://www.txsemi.com>

600mA High Speed Low Noise LDO

(7) Quiescent Current VS Temperature

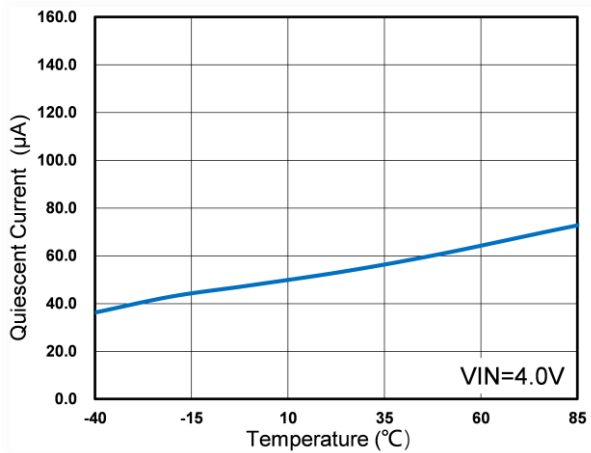

(8) Output Voltage VS Temperature

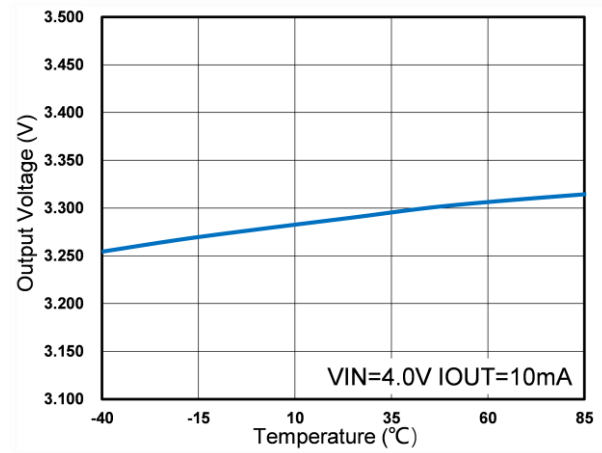

(9) Line Regulation VS Temperature

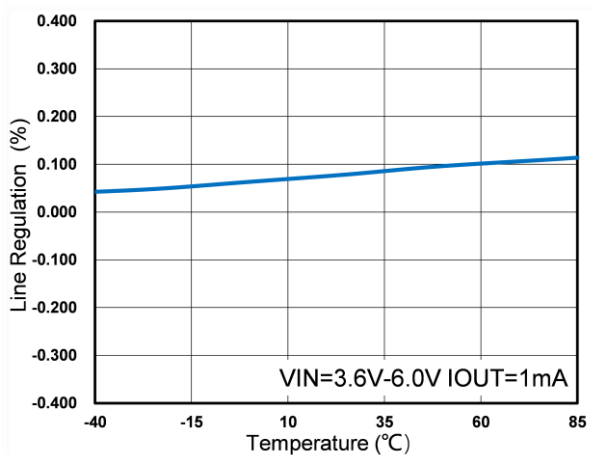

(10) Load Regulation VS Temperature

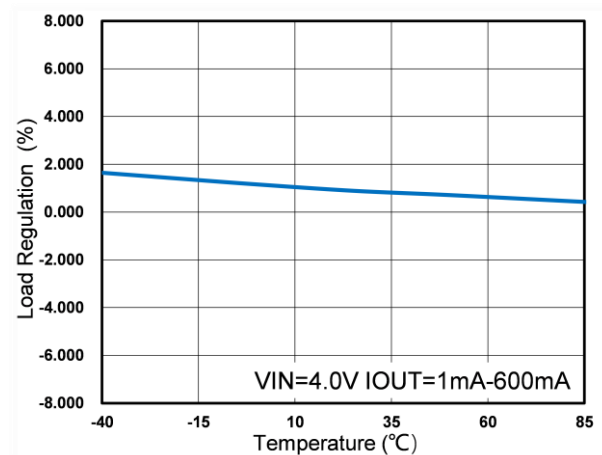

(11) Reference Voltage VS Temperature

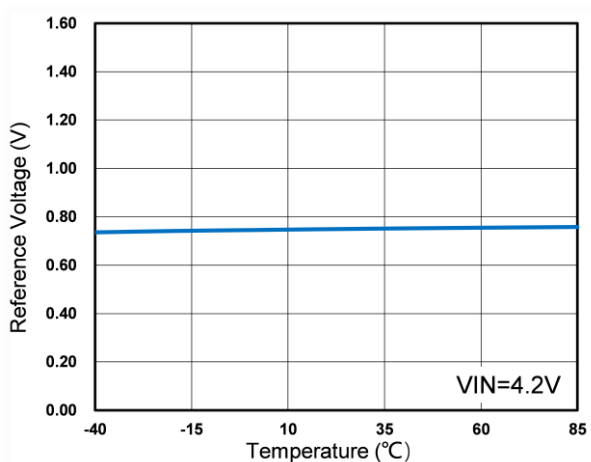

(12) PSRR

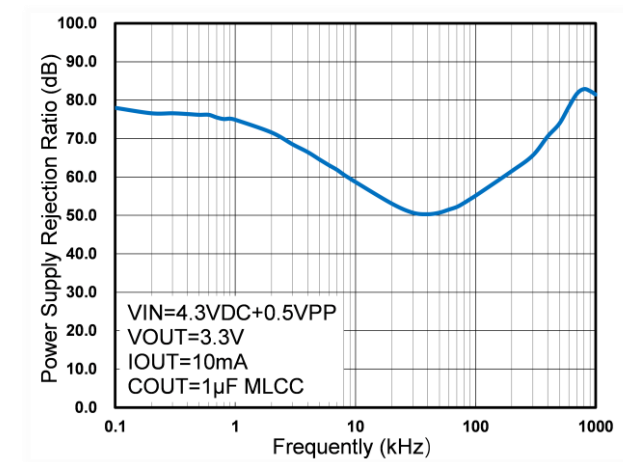



<http://www.txsemi.com>

TX6051

600mA High Speed Low Noise LDO

(13) Input Transient Response (VIN=3.3V-4.3V)

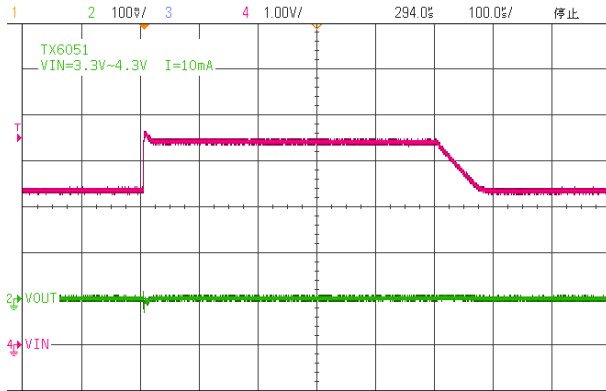

(14) Input Transient Response (VIN=3.3V-5.5V)

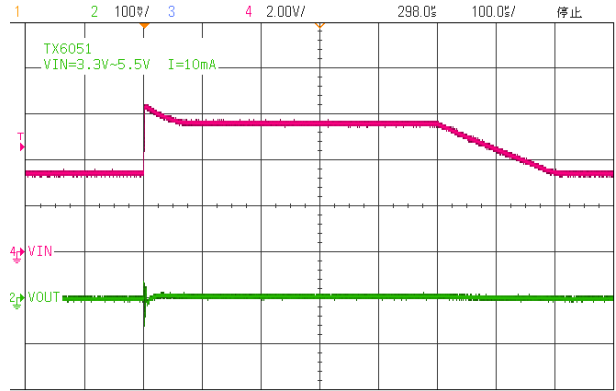

(15) Load Transient Response (IOUT=0mA-200mA)

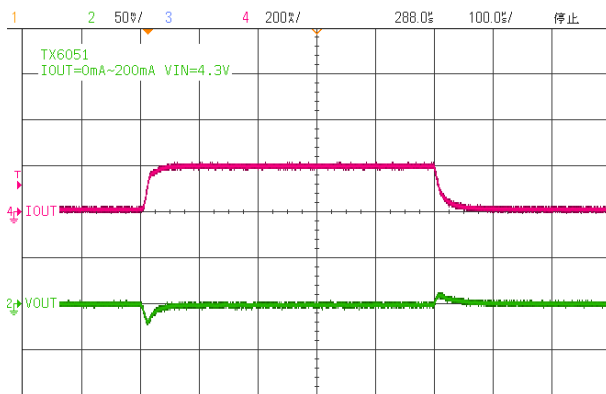

(16) Load Transient Response (IOUT=0mA-600mA)

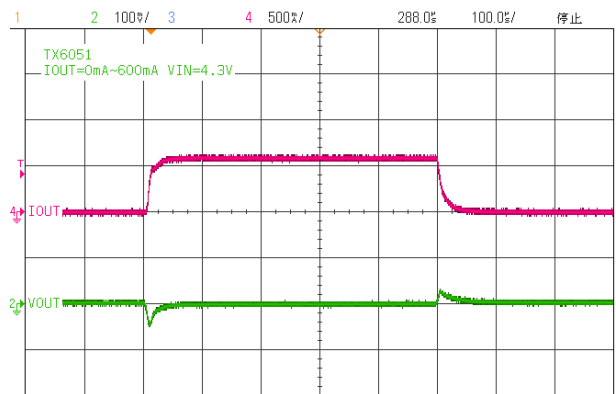

(17) Power ON (VIN=4.3V IOUT=10mA)

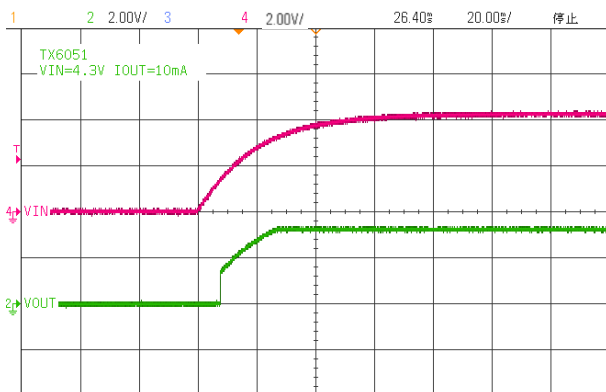

(18) Power OFF (VIN=4.3V IOUT=10mA)

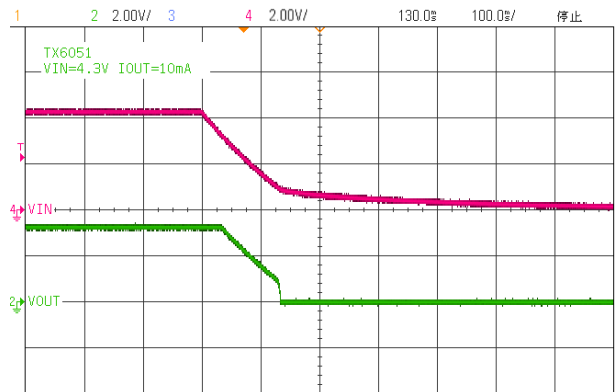



TX6051

<http://www.txsemi.com>

600mA High Speed Low Noise LDO

Marking Information

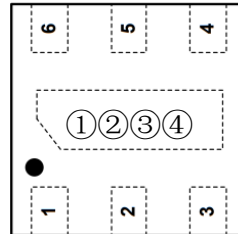
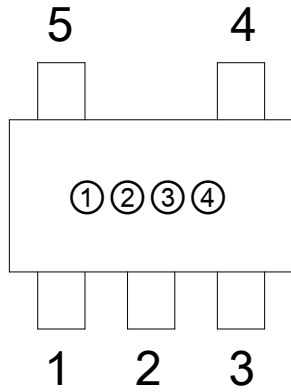

产品名称	①	②	③	④
TX6051A-adj	E	A	A	X
TX6051B-adj	E	a	a	X
TX6051C-adj	E	A	a	X



TX6051

<http://www.txsemi.com>

600mA High Speed Low Noise LDO

Package Information

- SOT-23-5L

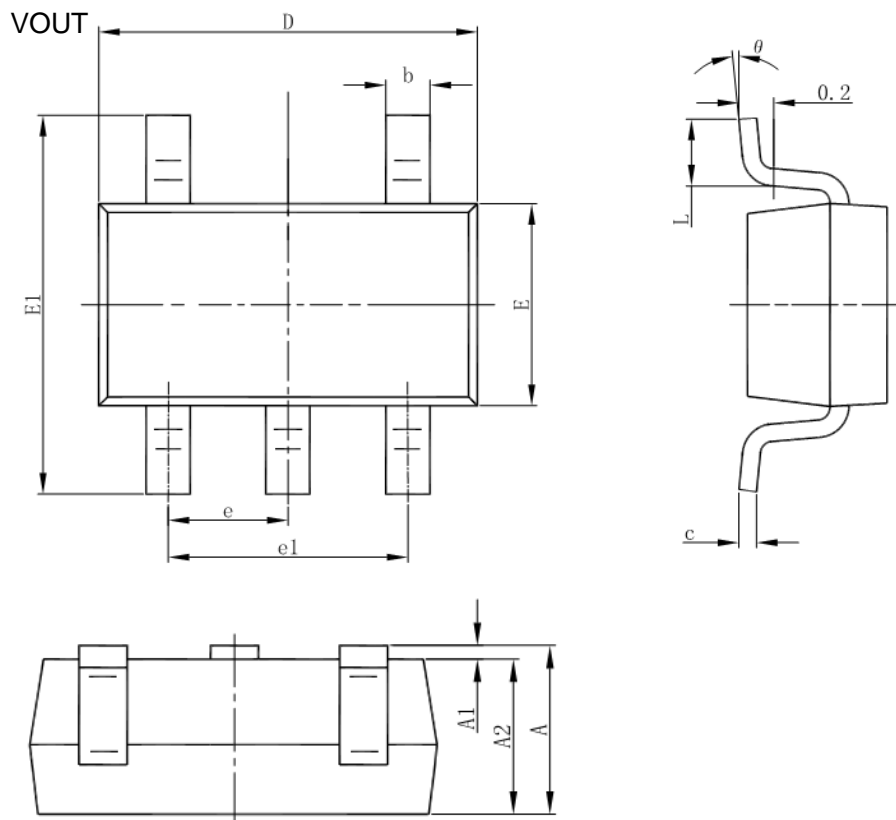

Symbol	Dimensions In Millimeters		Dimensions In Inches	
	Min	Max	Min	Max
A	1.050	1.250	0.041	0.049
A1	0.000	0.100	0.000	0.004
A2	1.050	1.150	0.041	0.045
b	0.300	0.500	0.012	0.020
c	0.100	0.200	0.004	0.008
D	2.820	3.020	0.111	0.119
E	1.500	1.700	0.059	0.067
E1	2.650	2.950	0.104	0.116
e	0.950(BSC)		0.037(BSC)	
e1	1.800	2.000	0.071	0.079
L	0.300	0.600	0.012	0.024
θ	0°	8°	0°	8°



TX6051

<http://www.txsemi.com>

600mA High Speed Low Noise LDO

- UDFN-1.2x1.2-6L

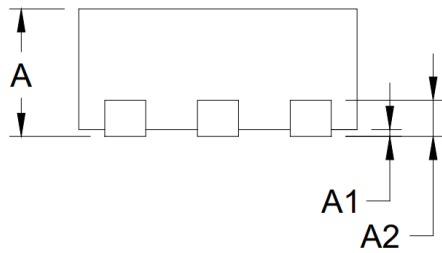
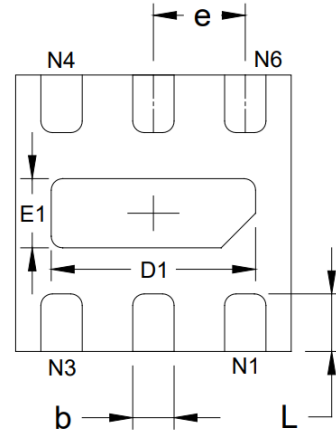
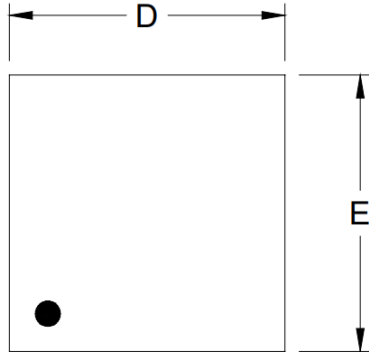

Symbol	Dimensions In Millimeters		
	MIN	MOD	MAX
A	0.500	0.550	0.600
A1			0.050
A2	0.152 REF		
e	0.400 BSC		
D	1.150	1.200	1.250
E	1.150	1.200	1.250
D1	0.840	0.890	0.940
E1	0.250	0.300	0.350
b	0.130	0.180	0.230
L	0.200	0.250	0.300



<http://www.txsemi.com>

TX6051 ***600mA High Speed Low Noise LDO***

© Shanghai TX Electronics Sci-Tech Co., Ltd

TX cannot assume responsibility for use of any circuitry other than circuitry entirely embodied in a TX product. No circuit patent license, copyrights or other intellectual property rights are implied. TX reserves the right to make changes to their products or specifications without notice. Customers are advised to obtain the latest version of relevant information to verify, before placing orders, that information being relied on is current and complete.